

Fig. 1

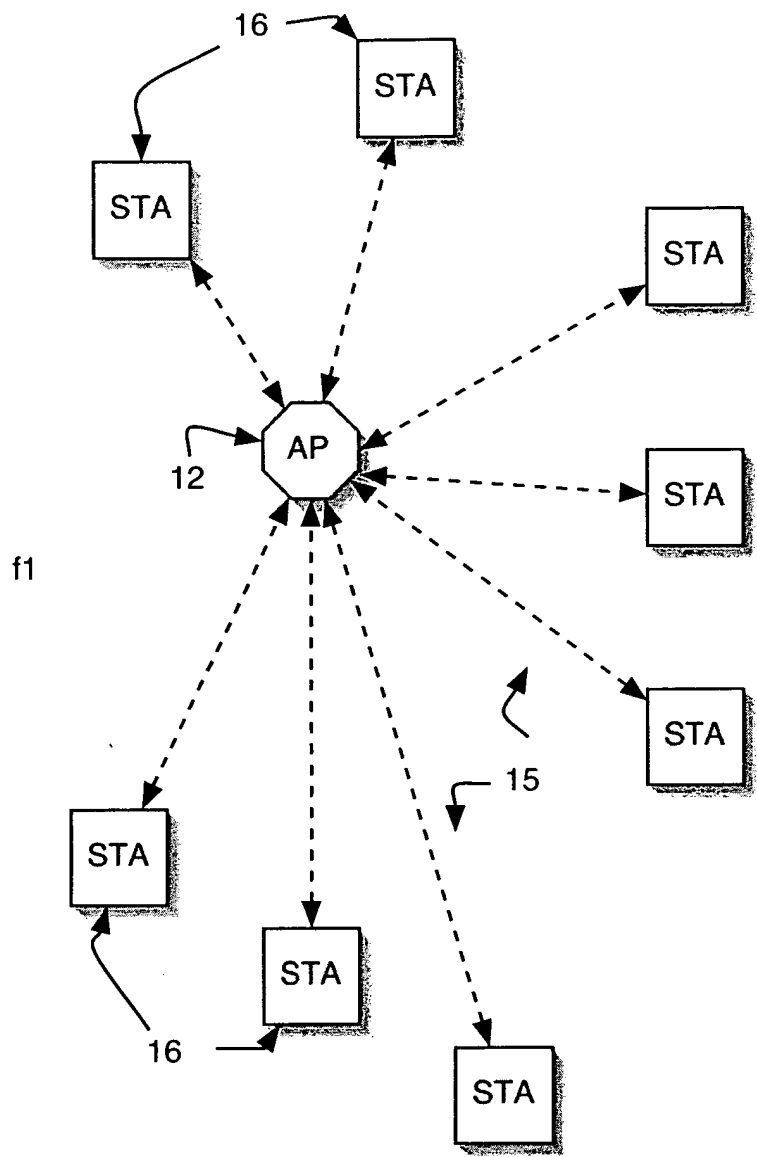

Fig. 2

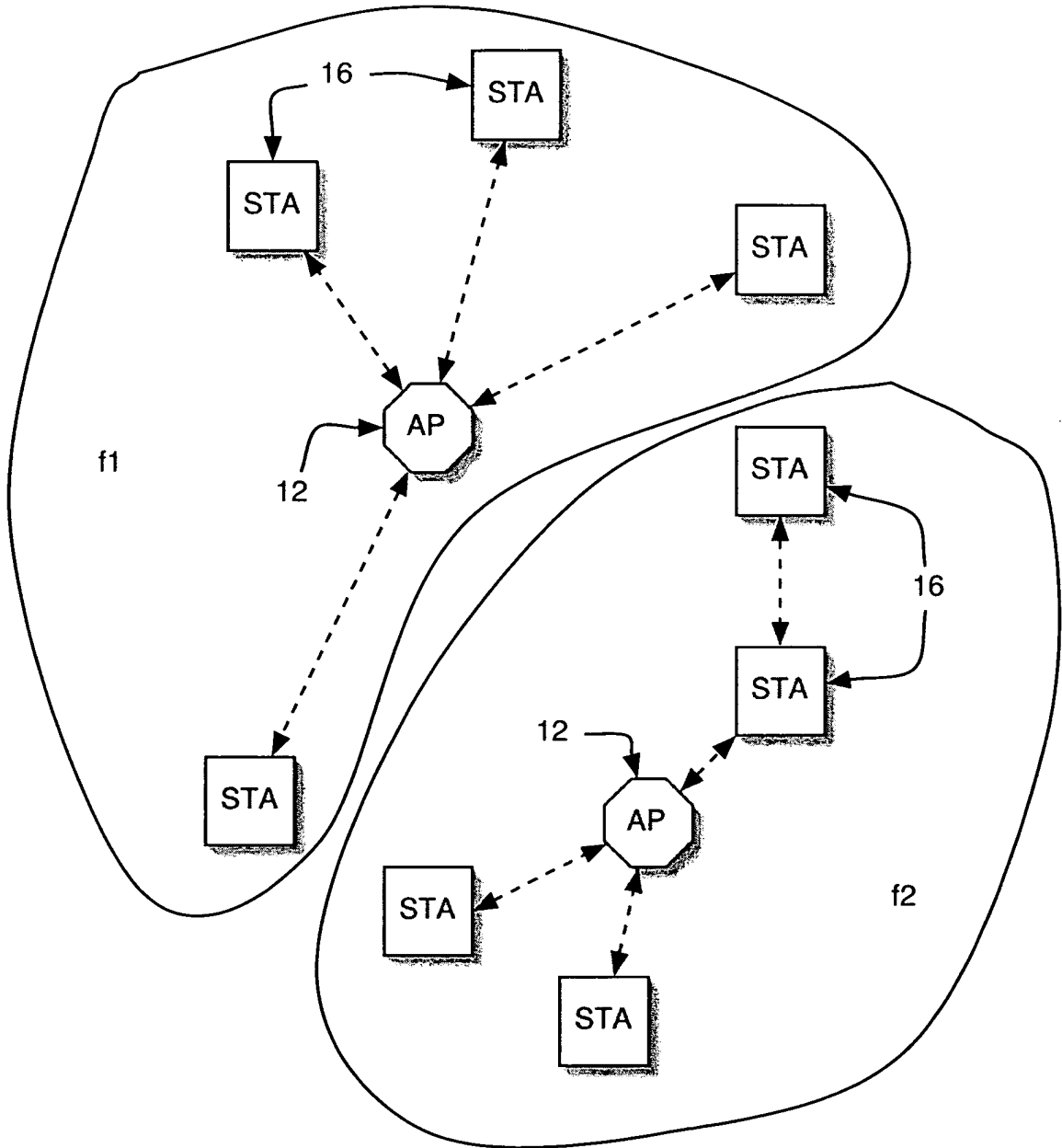

Fig. 3

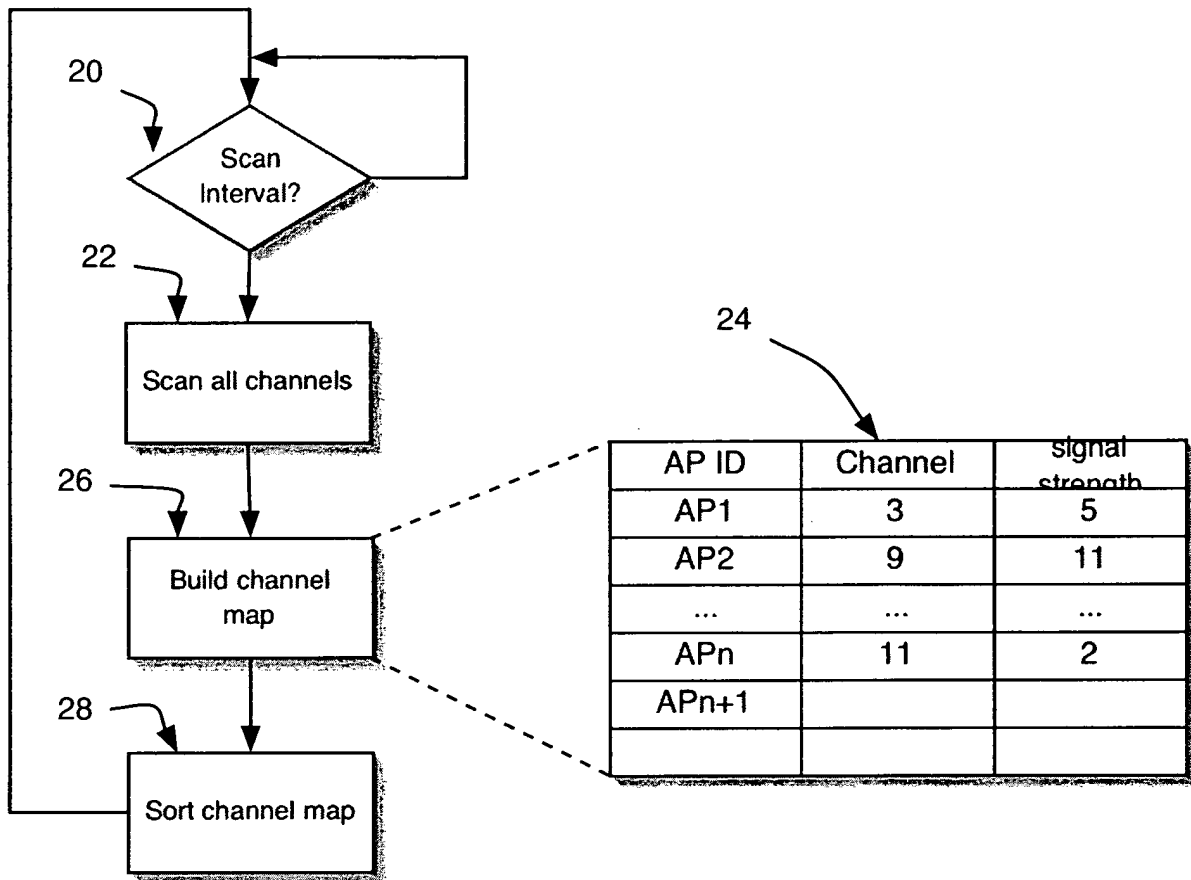

Fig. 4

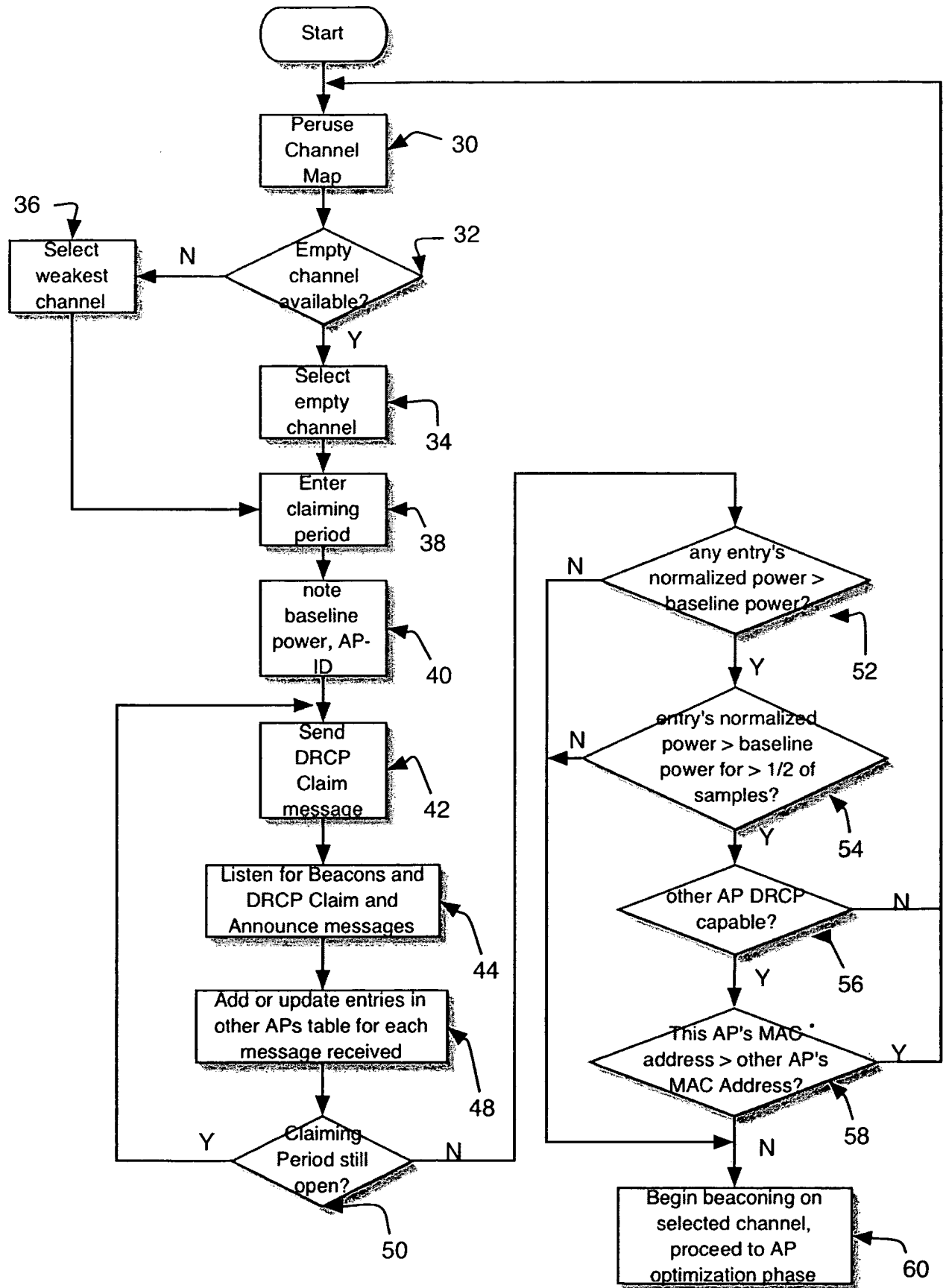



Fig. 5

46 

AP_ID	received power	TP Backoff	DRCP	Normalized received power
AP[1]	<list>	<list>	1	
AP[2]	0	?	0	
...
AP[n]	<list>	<list>	1	

Other APs Table

Fig. 6

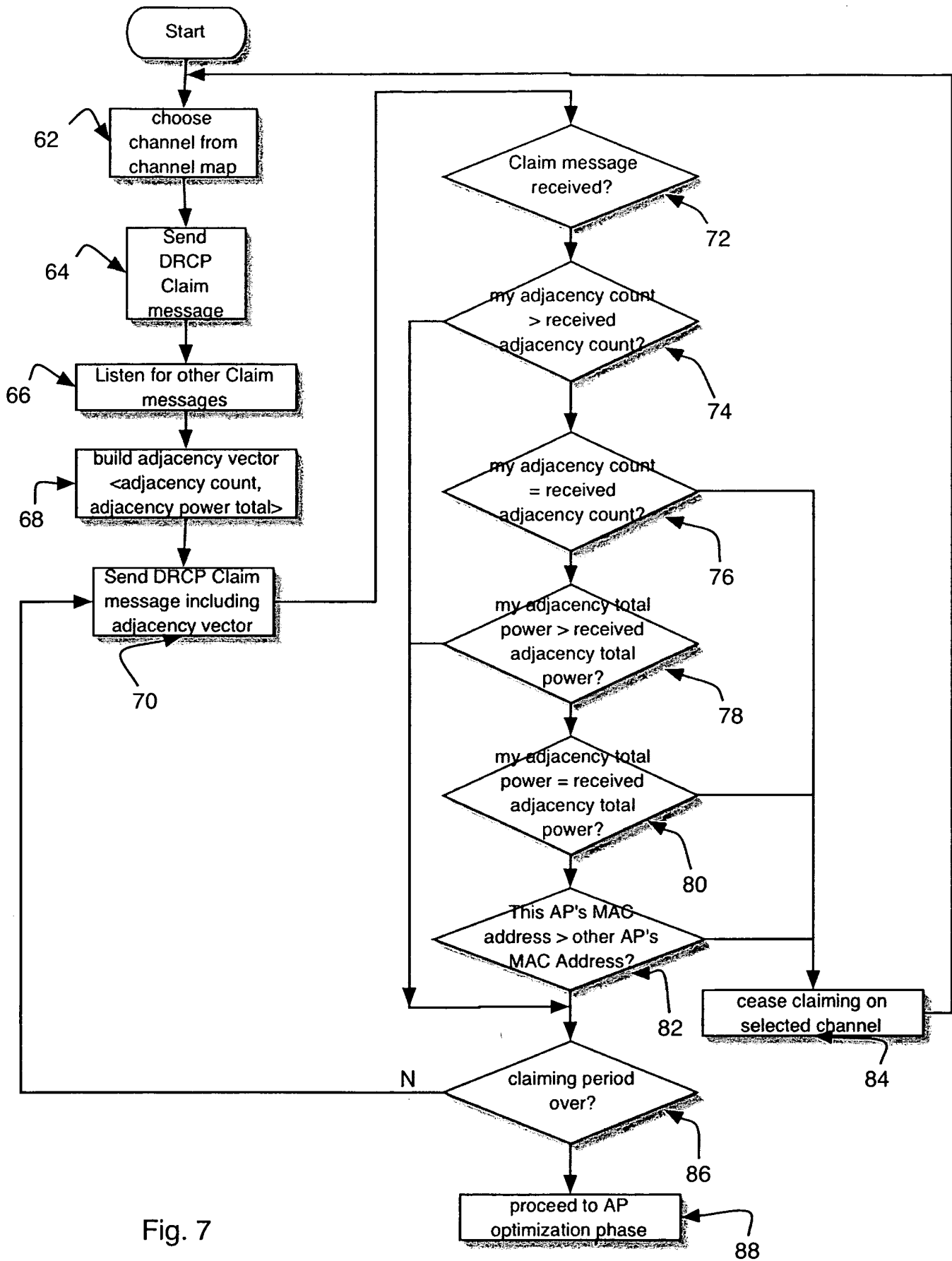

Fig. 7

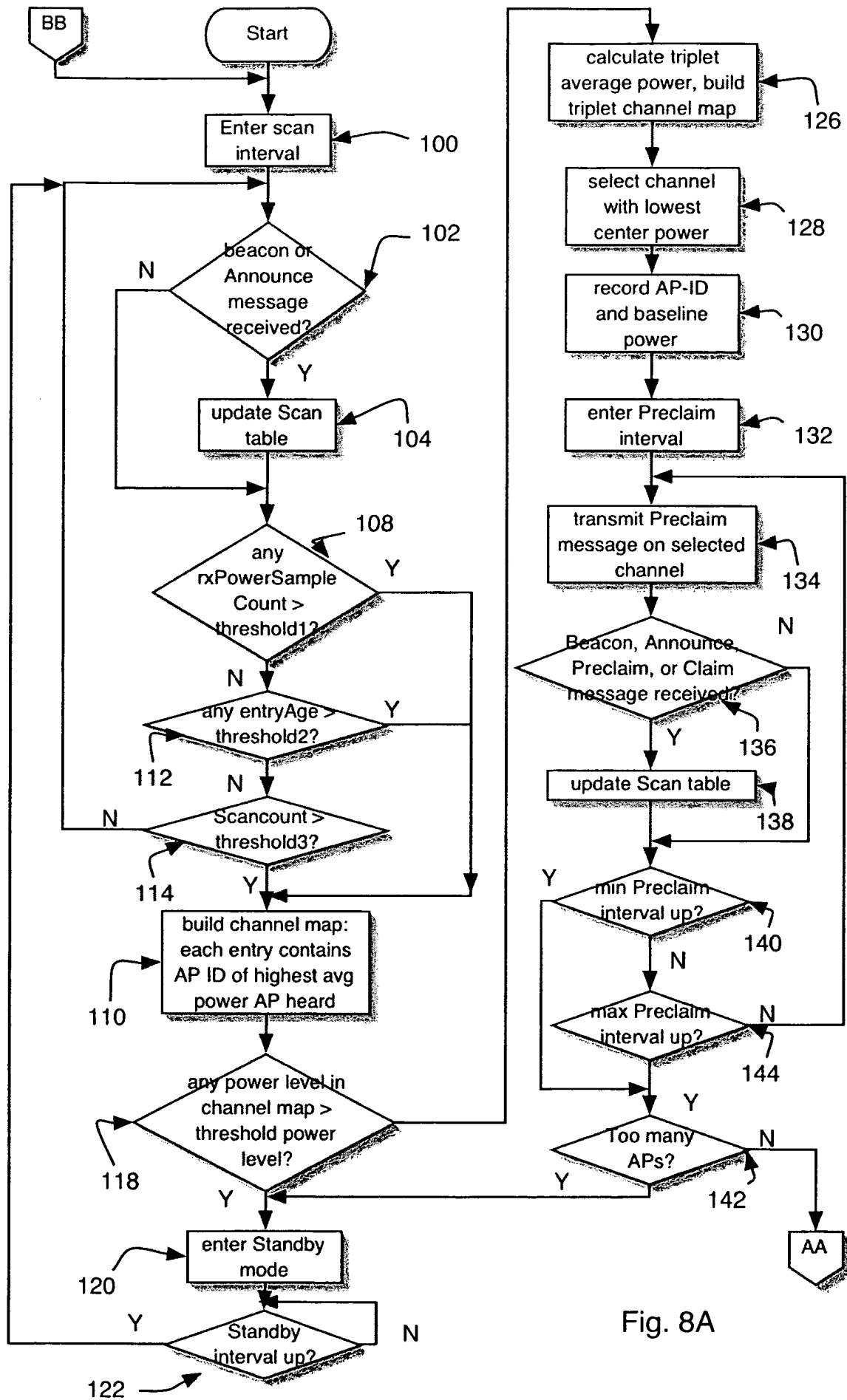

Fig. 8A

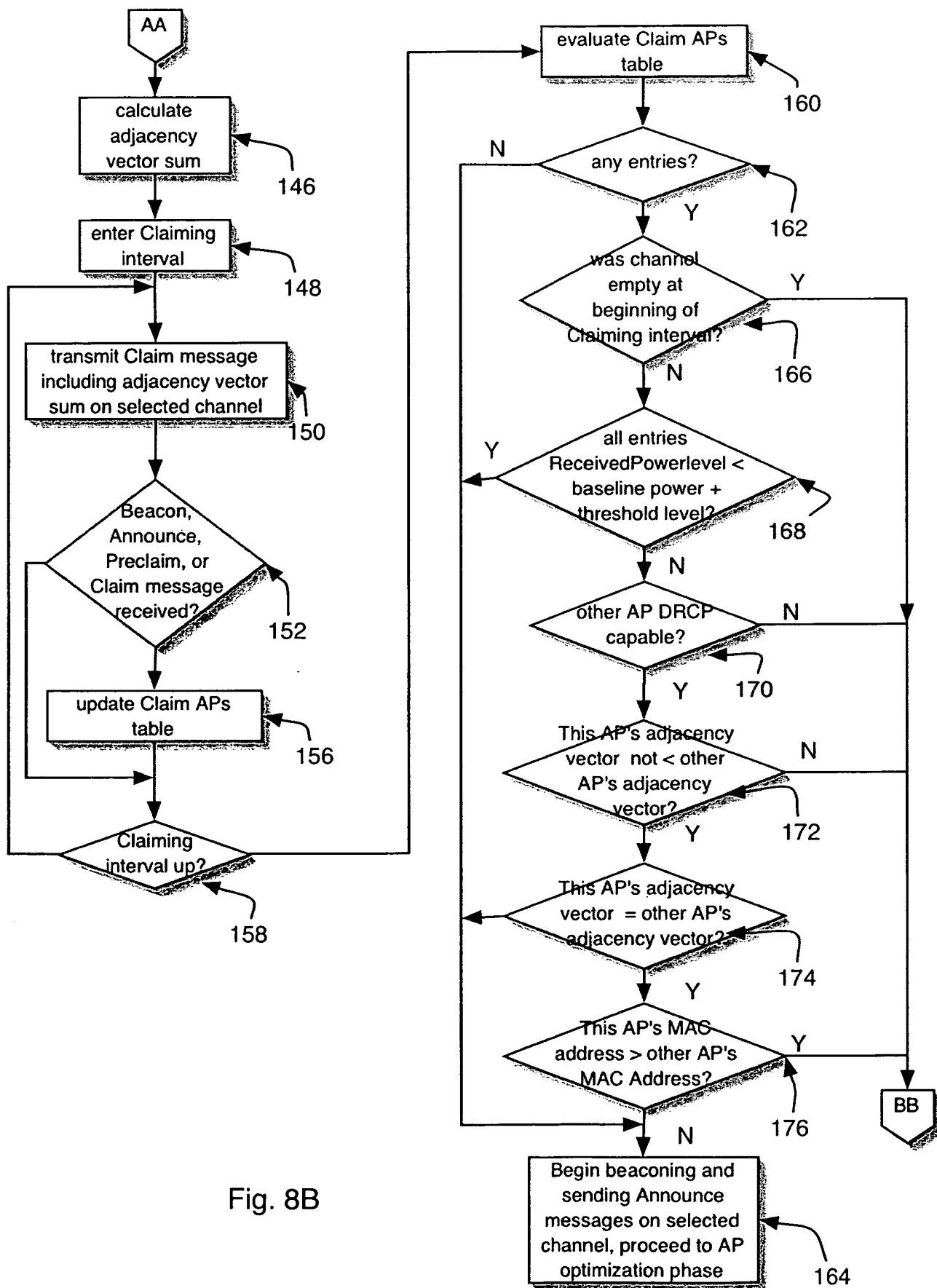

Fig. 8B

106 

AP_ID	Channel_ID	rxPowerRunning Total	rxPowerSample Count	rxPowerAvg	DRCP	Age
AP[1]	3	dbm	3	dbm	1	3
AP[2]	3	dbm	5	dbm	0	7
...	...	dbm
AP[n]	5	dbm	8	dbm	1	4

Scan Table

Fig. 9

116

Channel_ ID	highestPwr AP_ID	highestPwrlevel
2	AP[1]	dbm
3	AP[2]	dbm
...
8	AP[n]	dbm

Channel Map

Fig. 10

124

Channel	signal strength	Triplet avg	AP ID
2	5	5	3
3	2	5	11
4	8	5	2
1	3	6	8
2	9	6	6
3	6	6	1

Triplet channel map

Fig. 11

154

AP-ID	ReceivedPowerlevel	DRCP
2	<list>	5
3	<list>	7
4	<list>	3
7	<list>	6
9	<list>	9
11	<list>	12

Claim APs table

Fig. 12

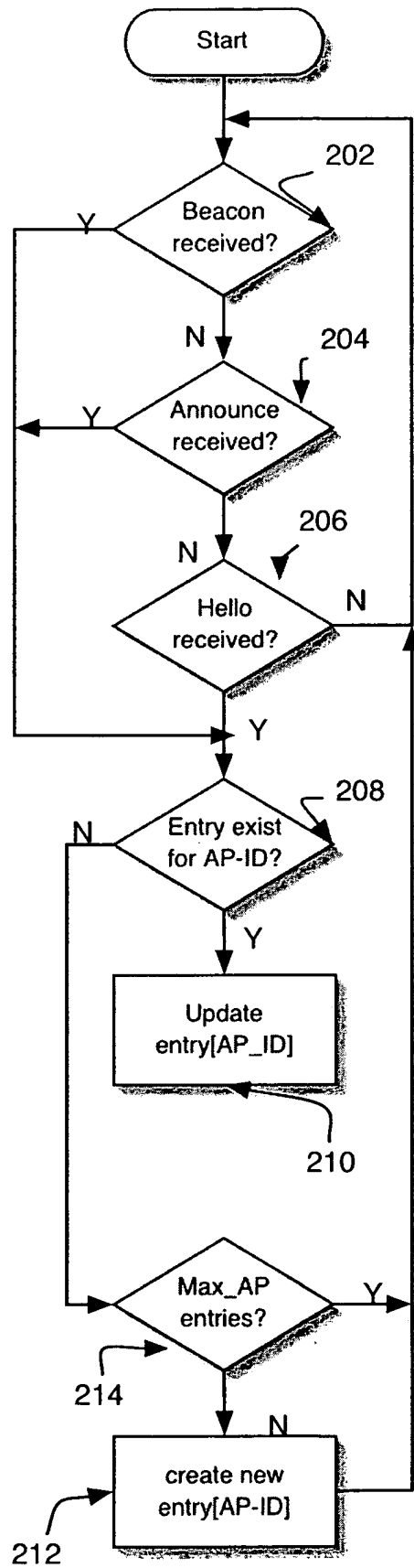

Fig. 13

200



AP_ID	TP_Backoff	Max Power	DRCP	Age	Normalized power	sample size	corrected power
AP[1]	<list>	<list>	1	2	dbm	3	dbm
AP[2]	0	max power	0	3	dbm	4	dbm
...
AP[MAX_AP]	<list>	<list>	1	1	dbm	1	dbm

AP Known APs Table

Fig. 14

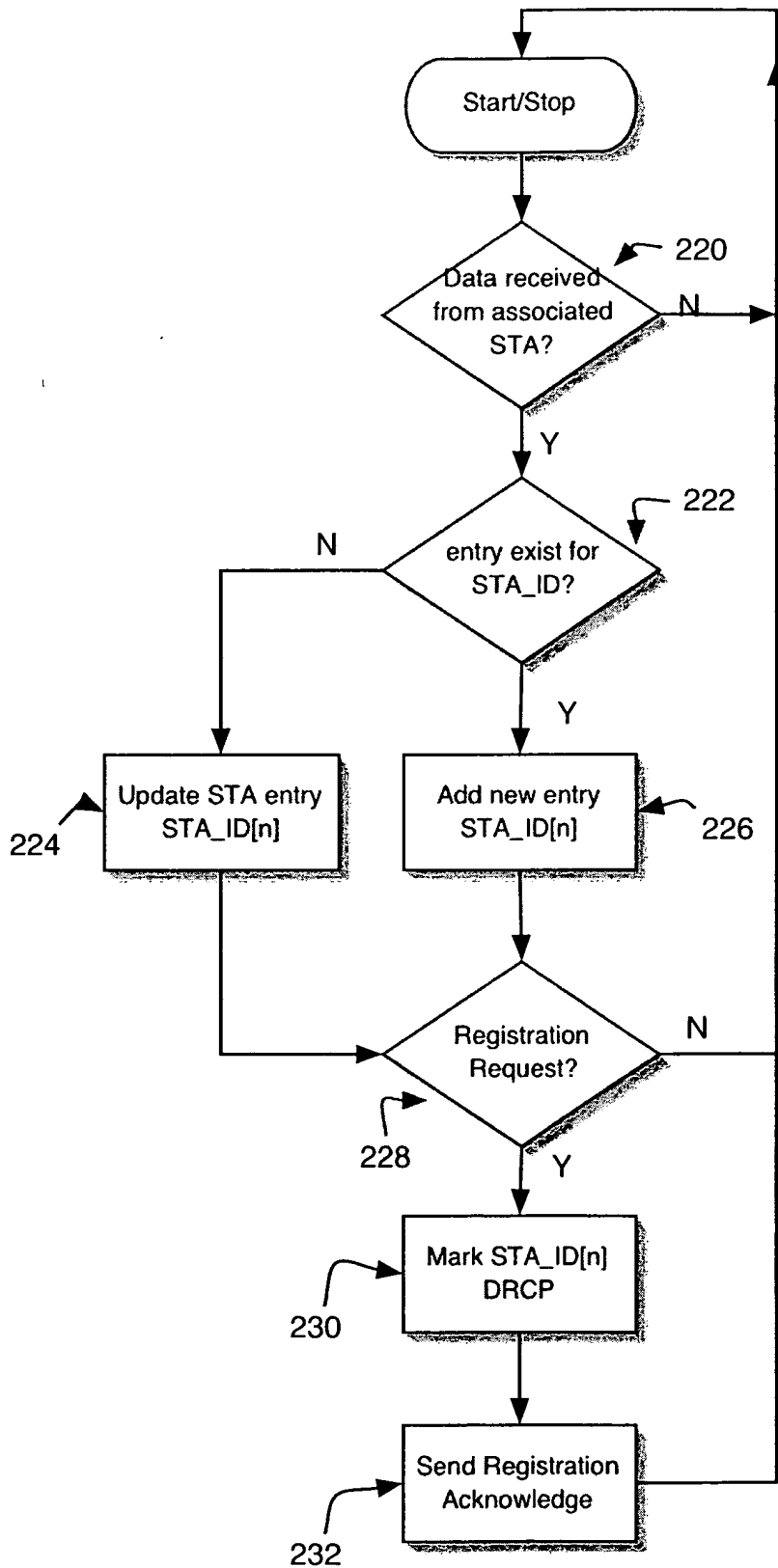

Fig. 15

240



STA_ID	Quiet-time	DRCP-Active	Distance	max power	sta_load_factor	power samples	normalized_power	corrected_power
STA[1]	4	1	1	1	2	1	1	1
STA[2]	0	0	0	0	3	0	0	0
...
STA[n]	6	1	3	1	1	1	1	1

AP AssociatedSTA Table

Fig. 16

AP Power Adjust

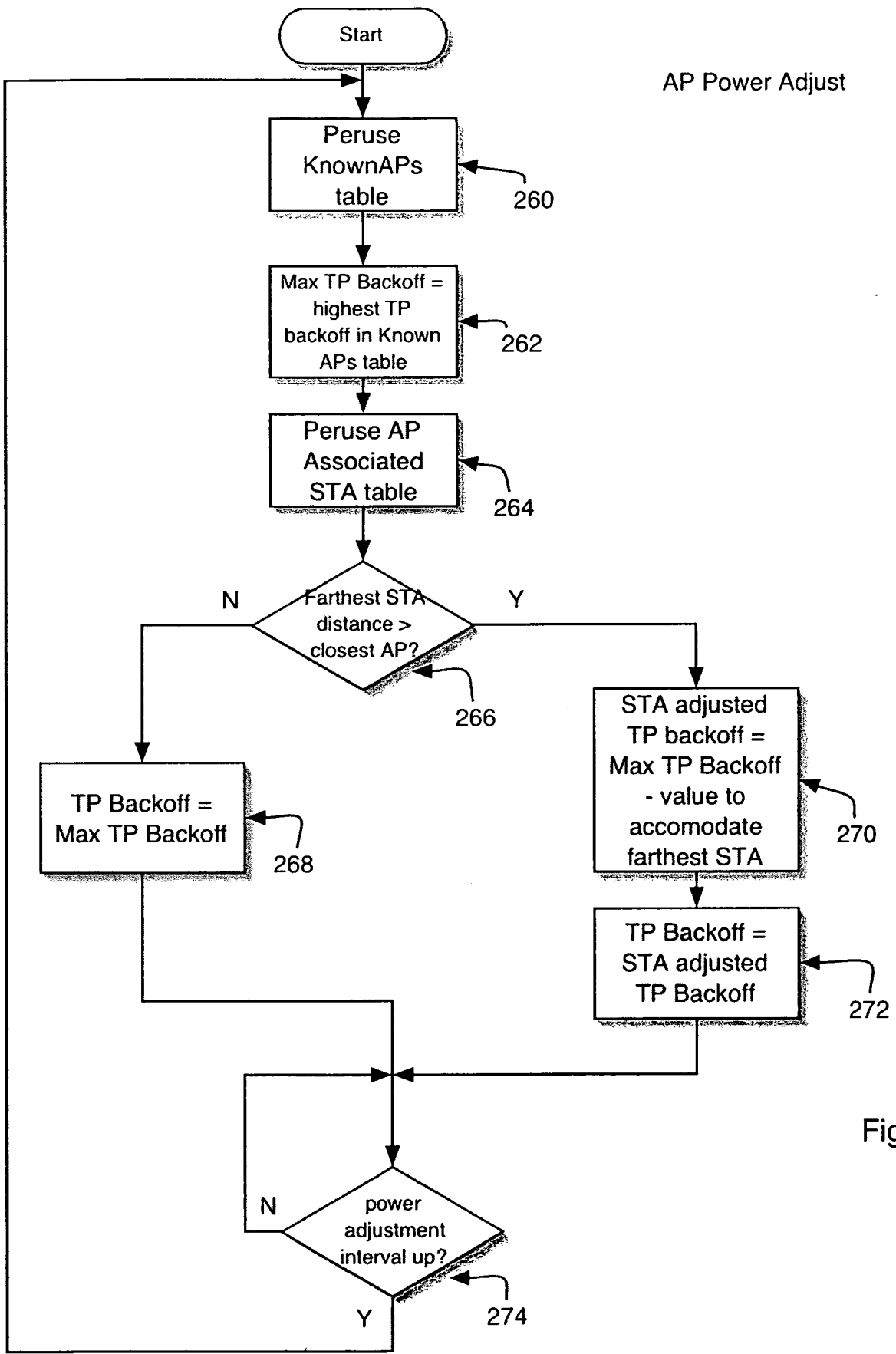

Fig. 17

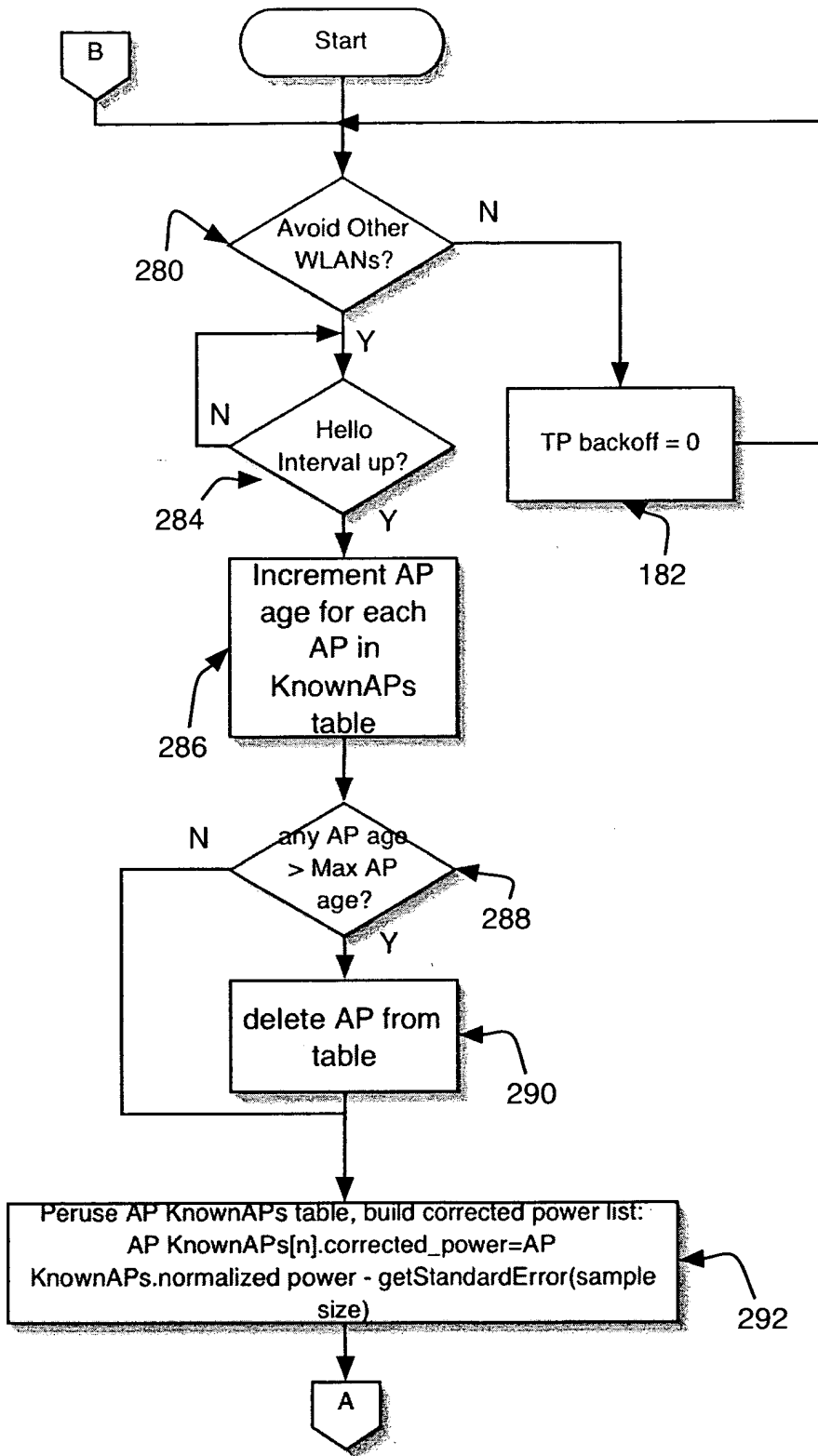

Fig. 18A

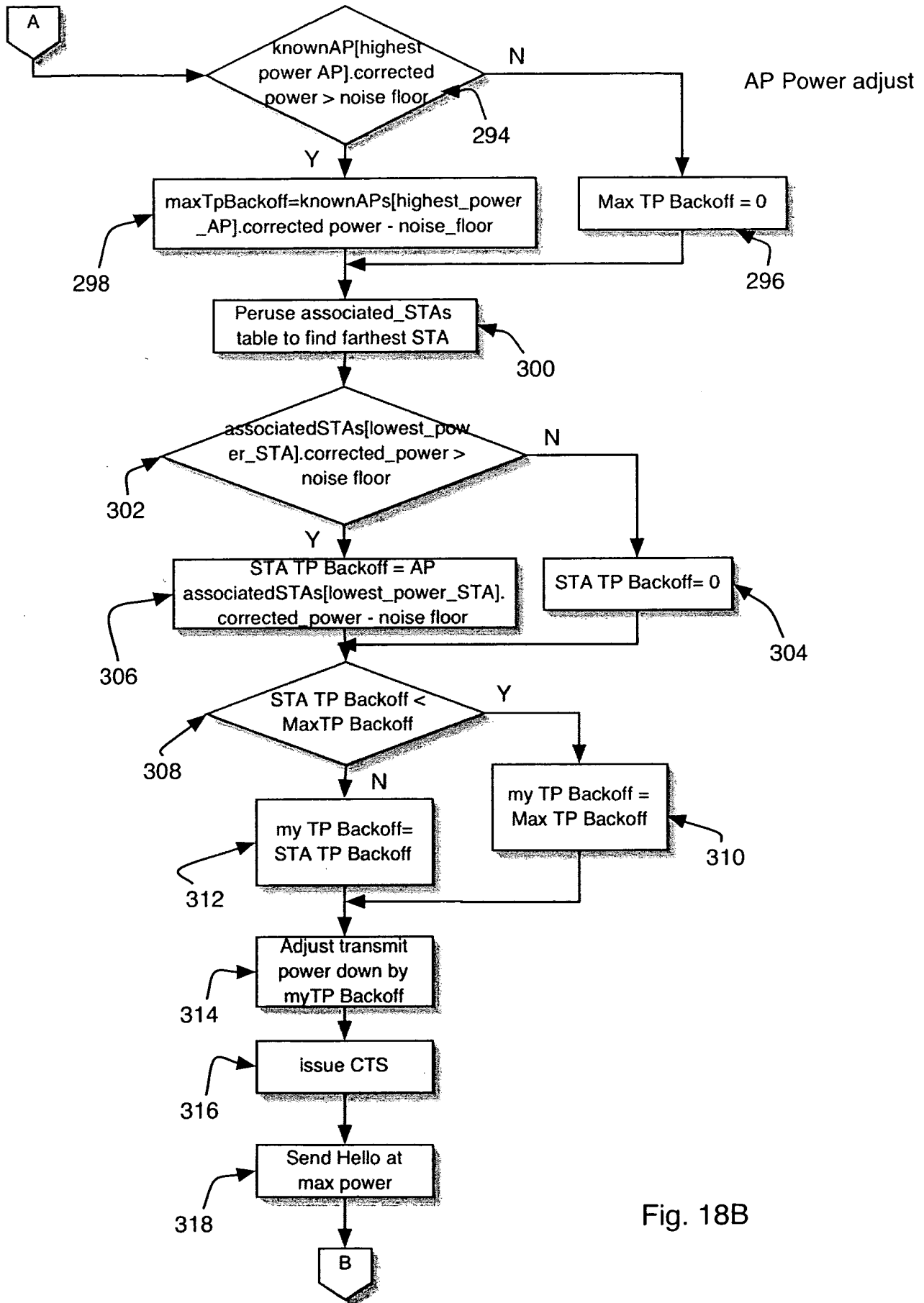

Fig. 18B

Number of Samples	Calculated Standard Error (+/- dB)	Rounded Standard Error (+/- dB)
2	38.6	39
4	22.3	22
8	14.6	15
16	9.94	10
32	6.9	7
64	4.9	5
128	3.4	3
256	2.3	2
512	1.7	2
1024	.8<dB<1.7	1
2000	.8	1
2048	0<dB<.8	1

Table I

Standard error for 99% confidence on received power values averaged over number of samples for standard deviation = 15 dB.

Fig. 19

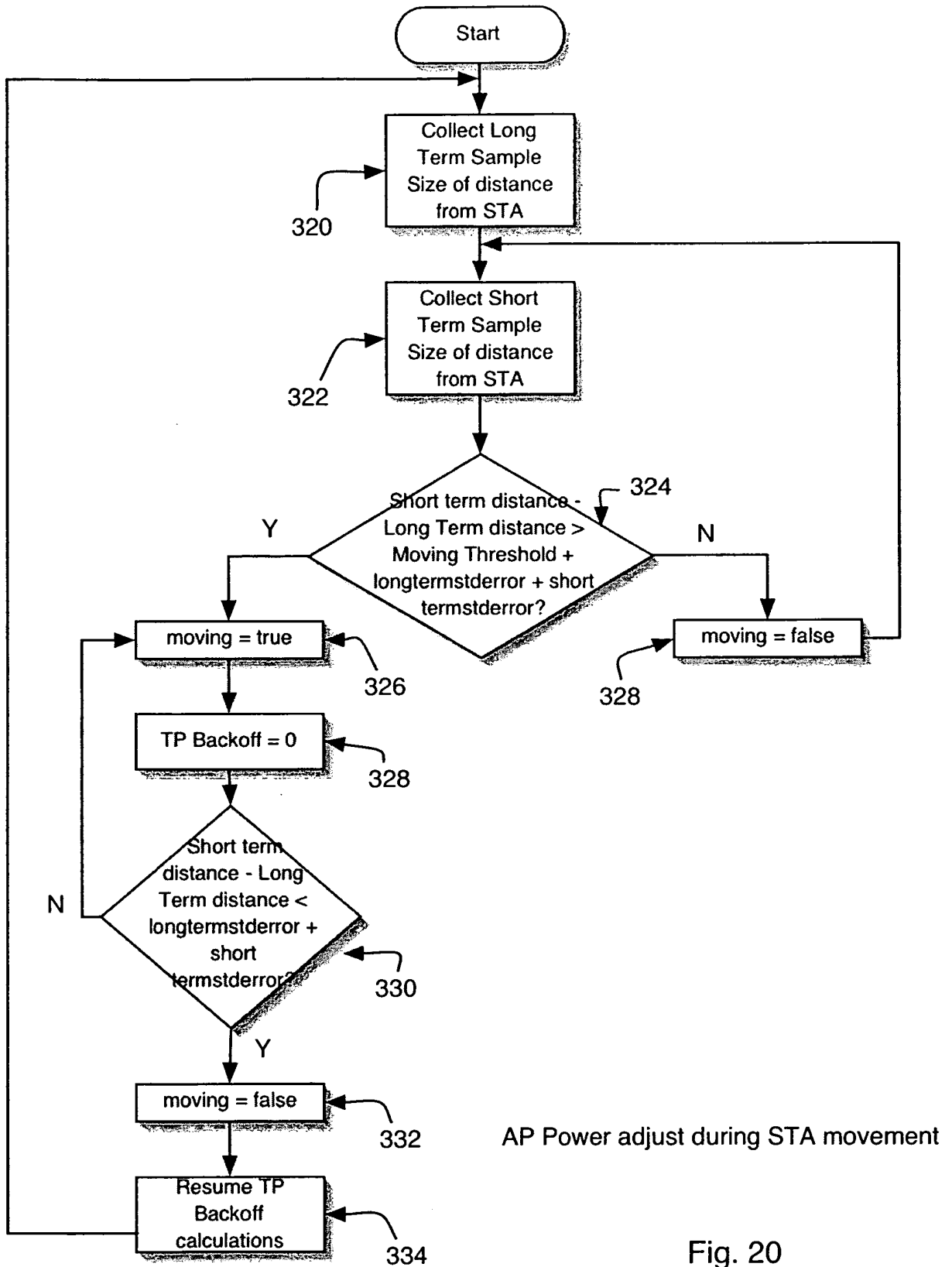

Fig. 20

AP Auction

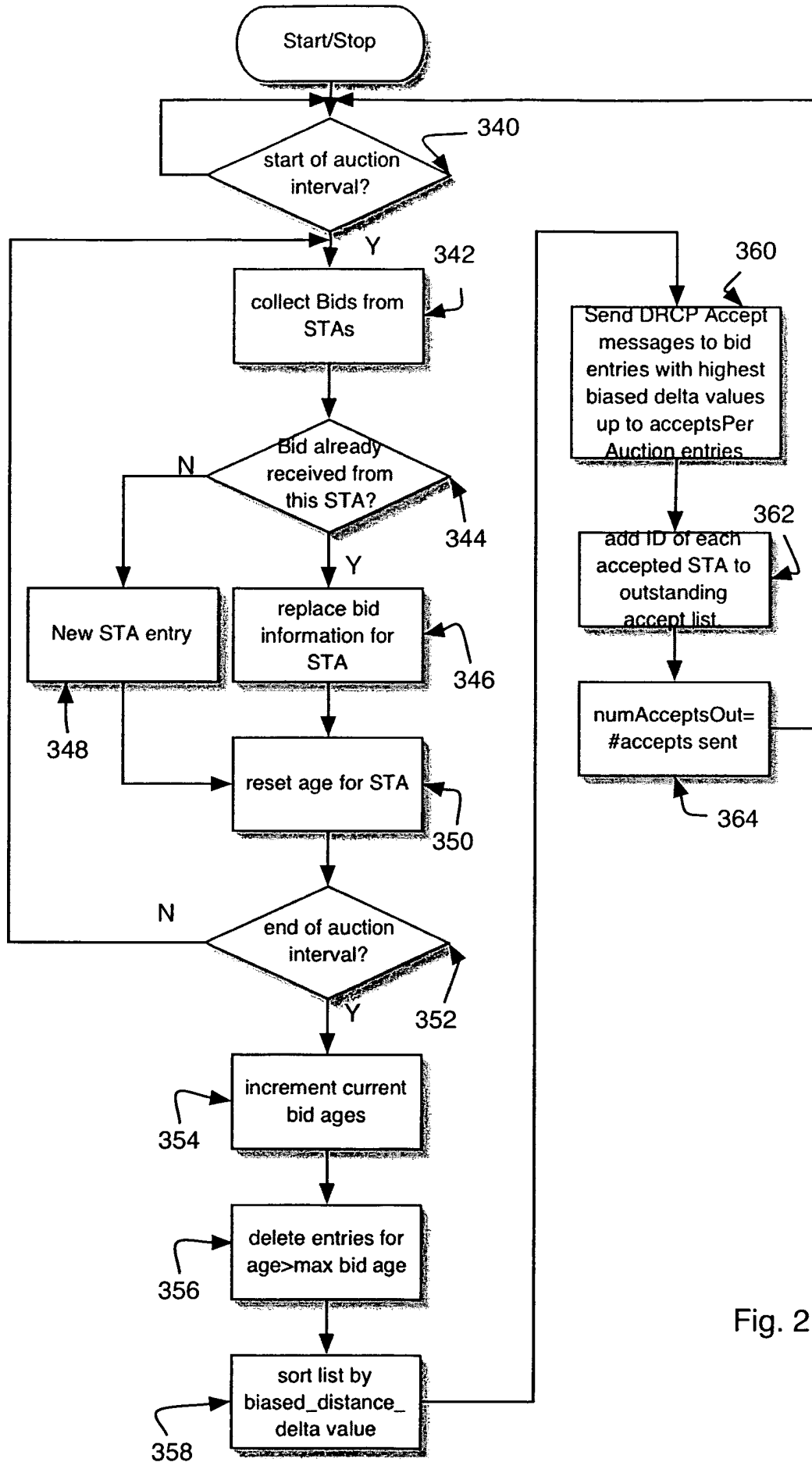

Fig. 21

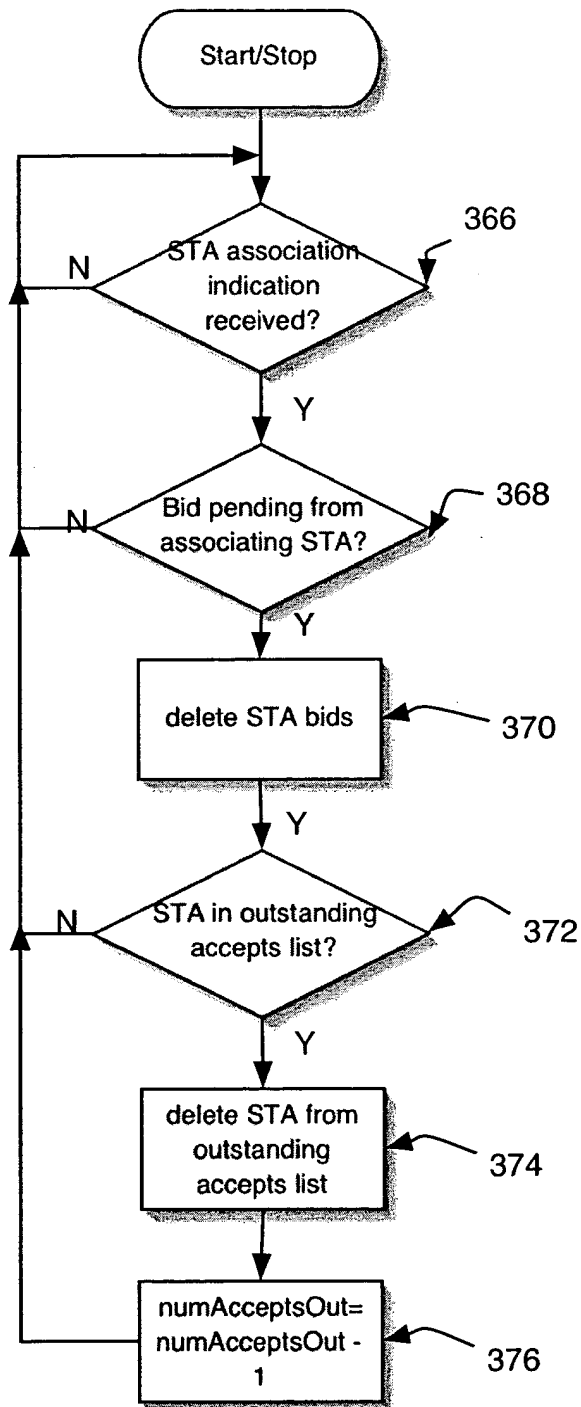

Fig. 22

STA Initialization

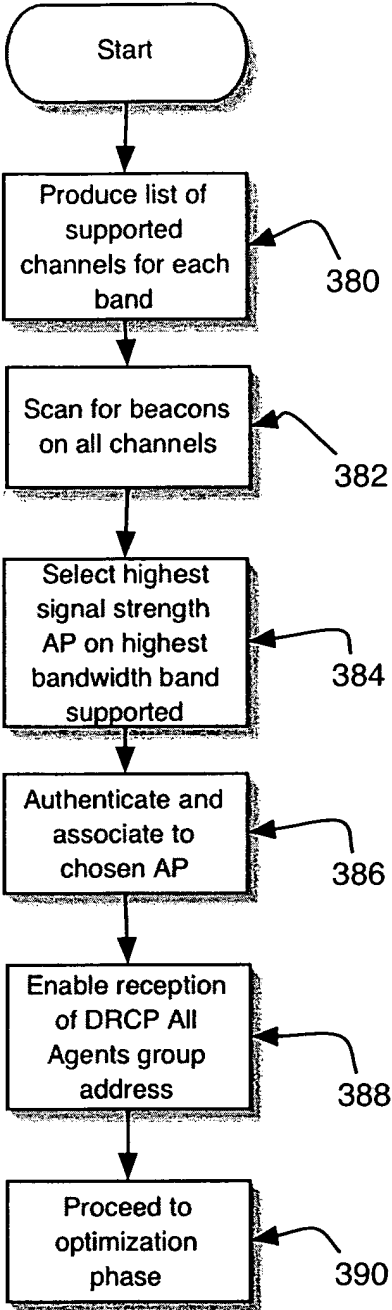

Fig. 23

STA Canvassing

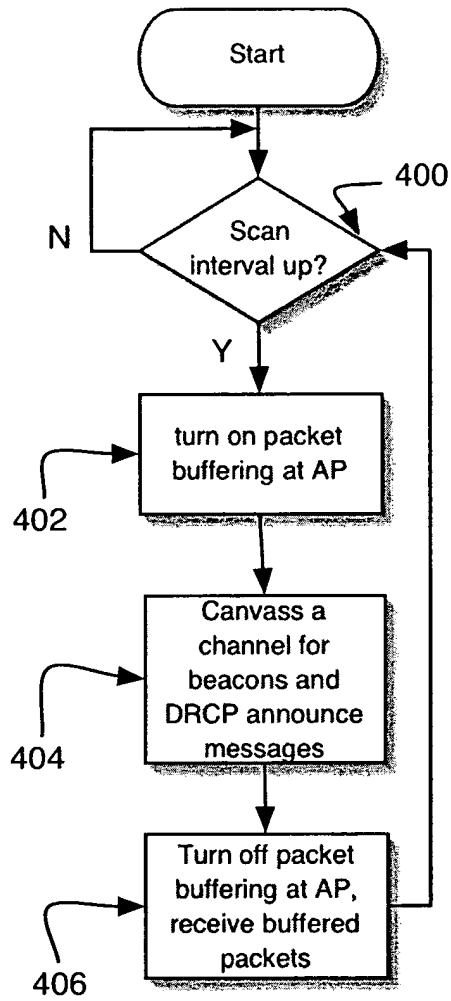

Fig. 24

STA Canvassing, 802.11

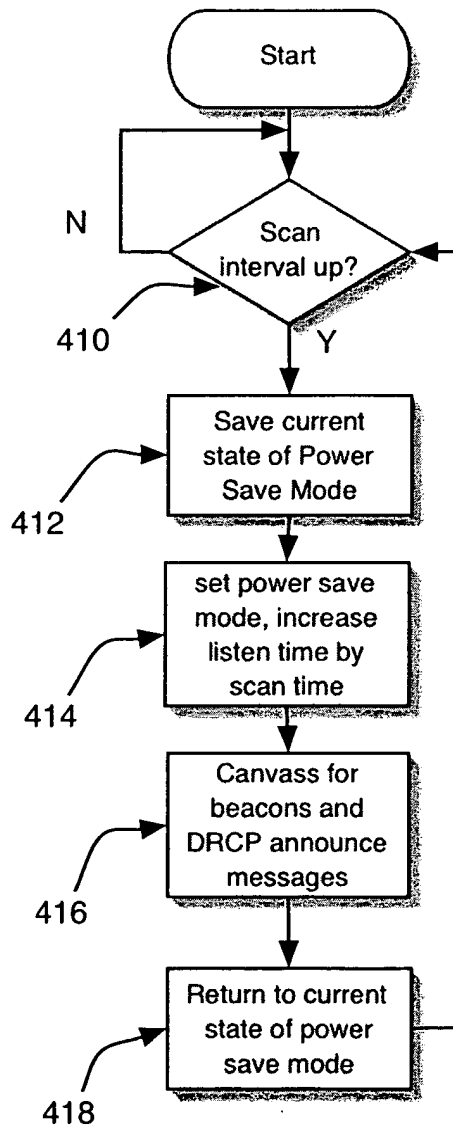

Fig. 25

430 →

AP_ID	Channel ID	age	Load Factor	TP Backoff	Max Power	distance_sample s	distance	my_Load Factor	biased distance	corrected distance
AP[1]	3	2	2	<list>	<list>	10	avg	2	2	2
AP[2]	7	3	3	<list>	<list>	7		3	3	3
...	5
AP[MAX_AP]	2	1	1	<list>	<list>	13		1	1	1

STA Known APs Table

Fig. 26

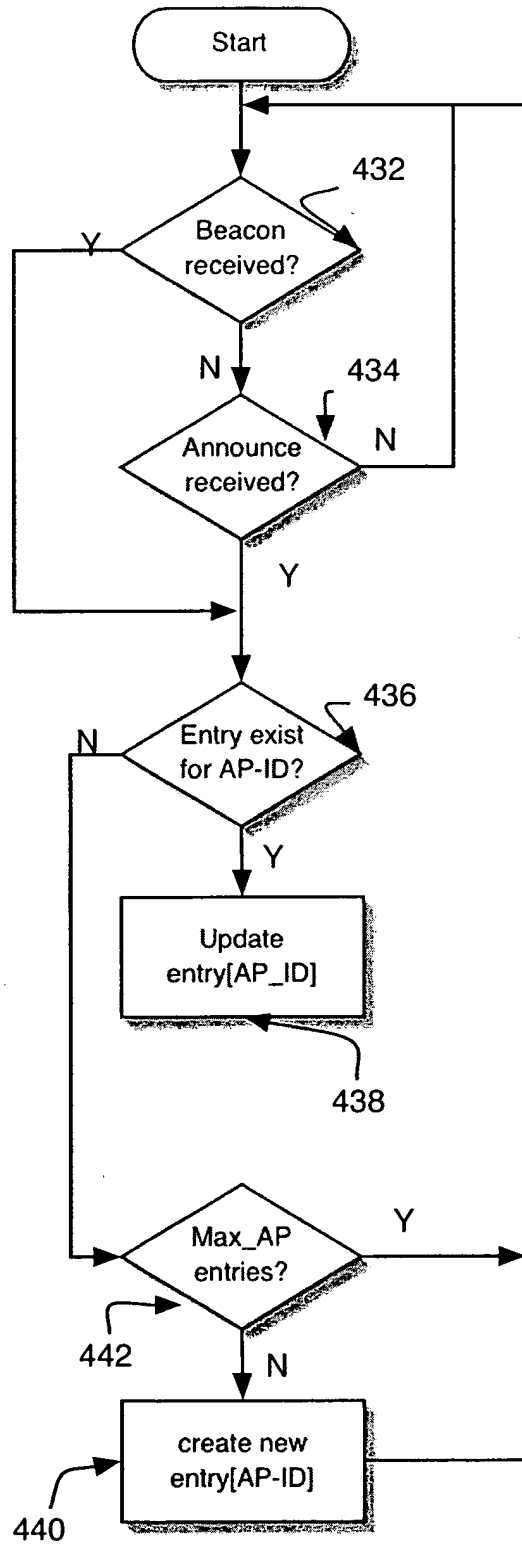

Fig. 27

STA Power Adjustment

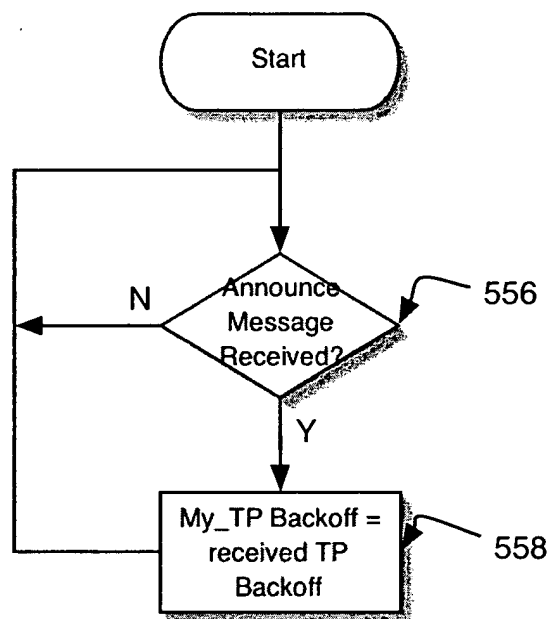

Fig. 28

STA Bidding

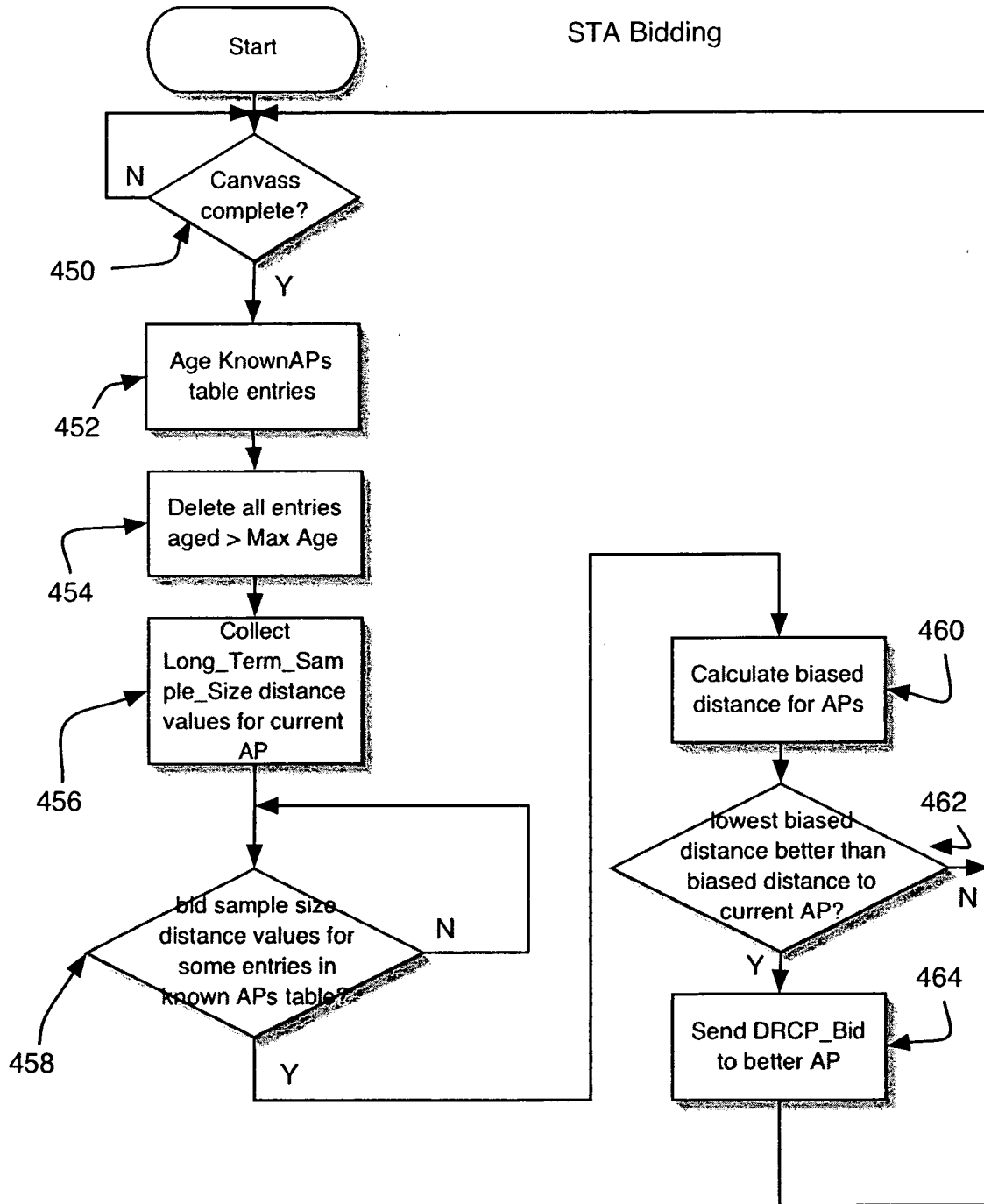

Fig. 29

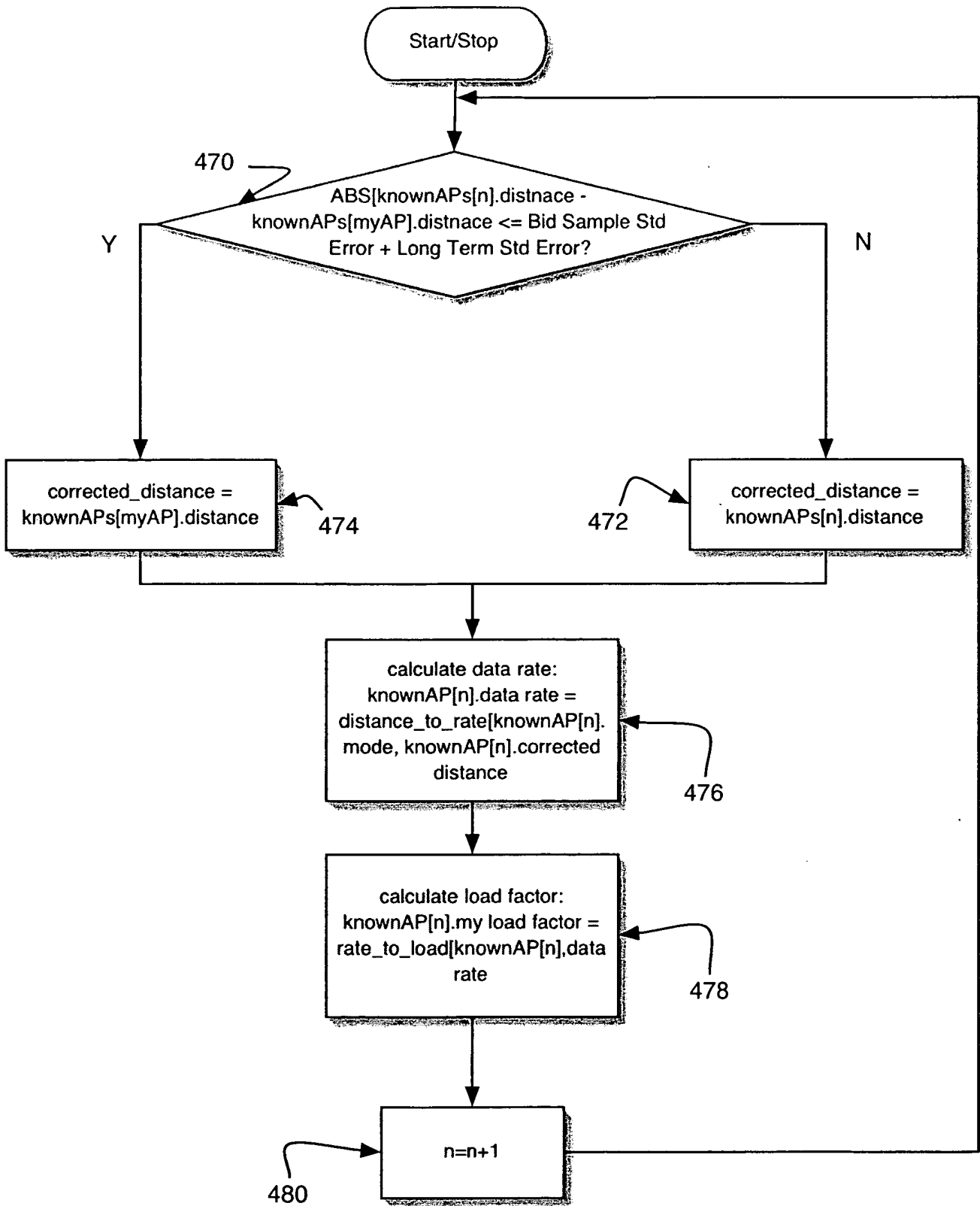

Fig. 30

Distance in Banzais	802.11a, g Mb/s	802.11b Mb/s
0-68	54	11
69-72	48	11
73-76	36	11
77-80	24	11
81-83	18	11
84-85	12	5.5
86	9	5.5
87	9	2
88	6	2
89	2	2
90-91	2	1
92-94	1	0
95-97	.5	0

Table II
Distance_to_Rate Table, 802.11

Fig. 31

Data Rate	Load Factor
108	4
72	6
54	8
48	9
36	12
24	18
18	24
11	39
9	48
6	72
5.5	79
2	216
1	432
.5	864
0	65,535

Table III

Rate_to_Load table for 802.11

Fig. 32

Biased Distance Calculation

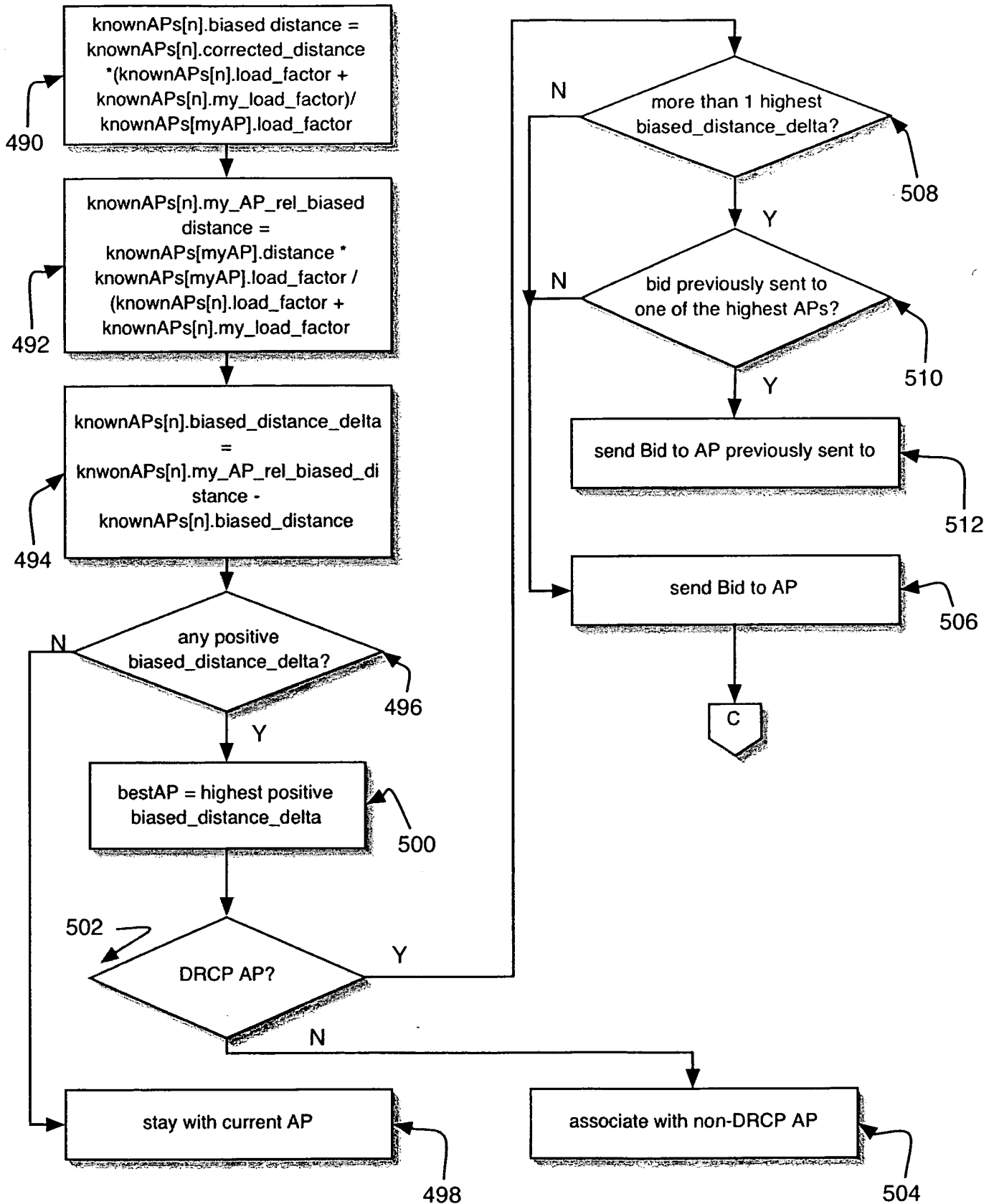

Fig. 33A

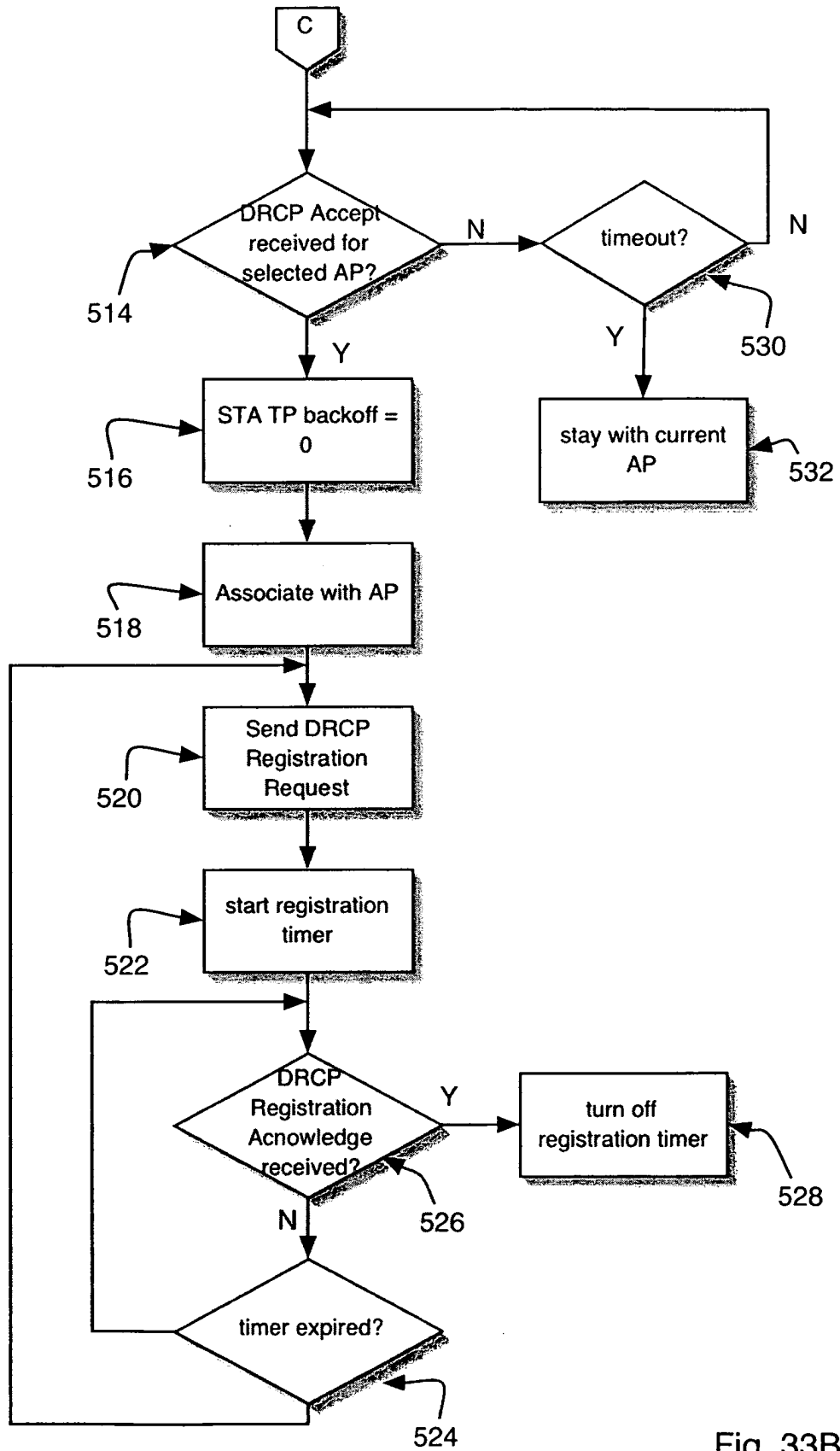

Fig. 33B

STA movement detection

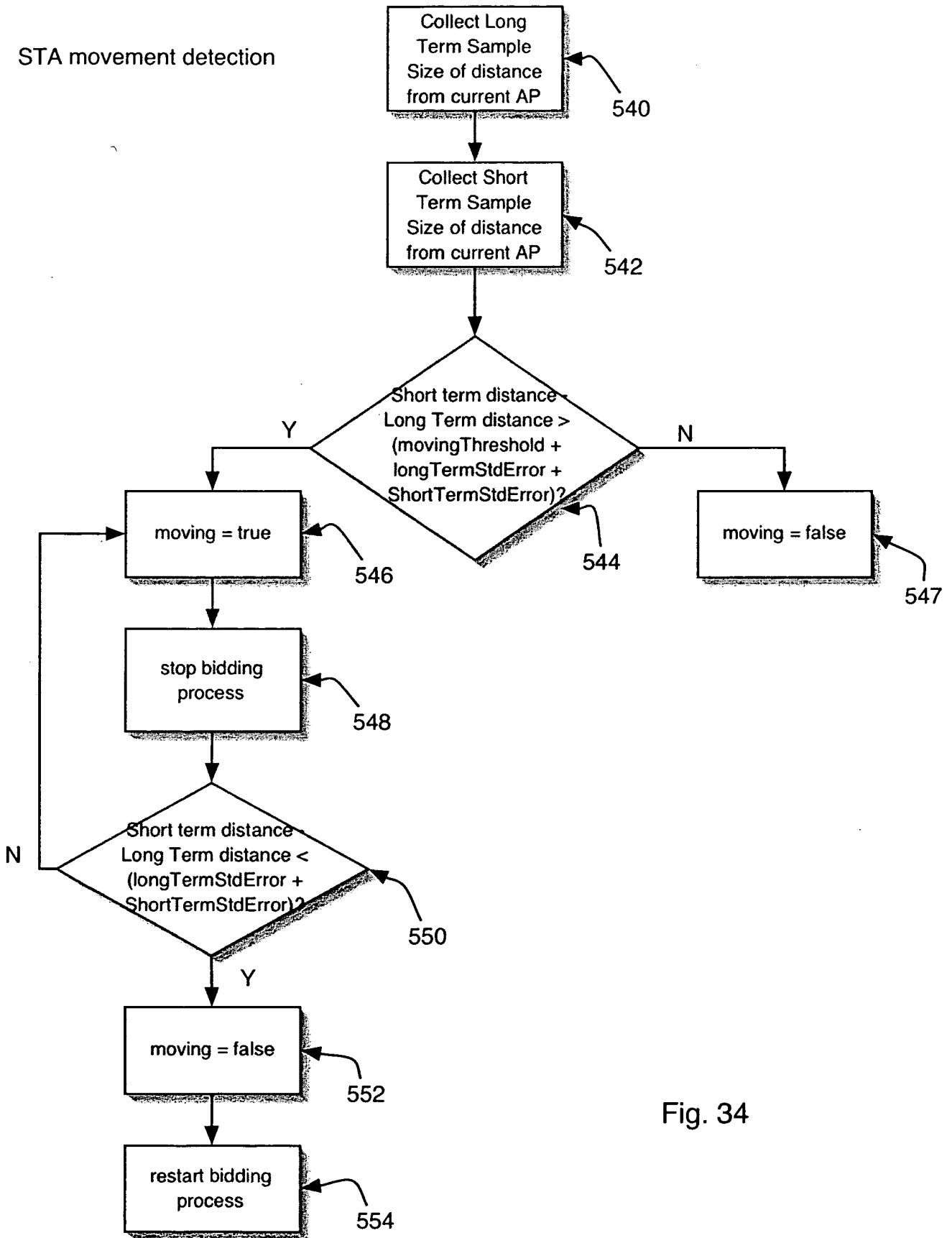

Fig. 34

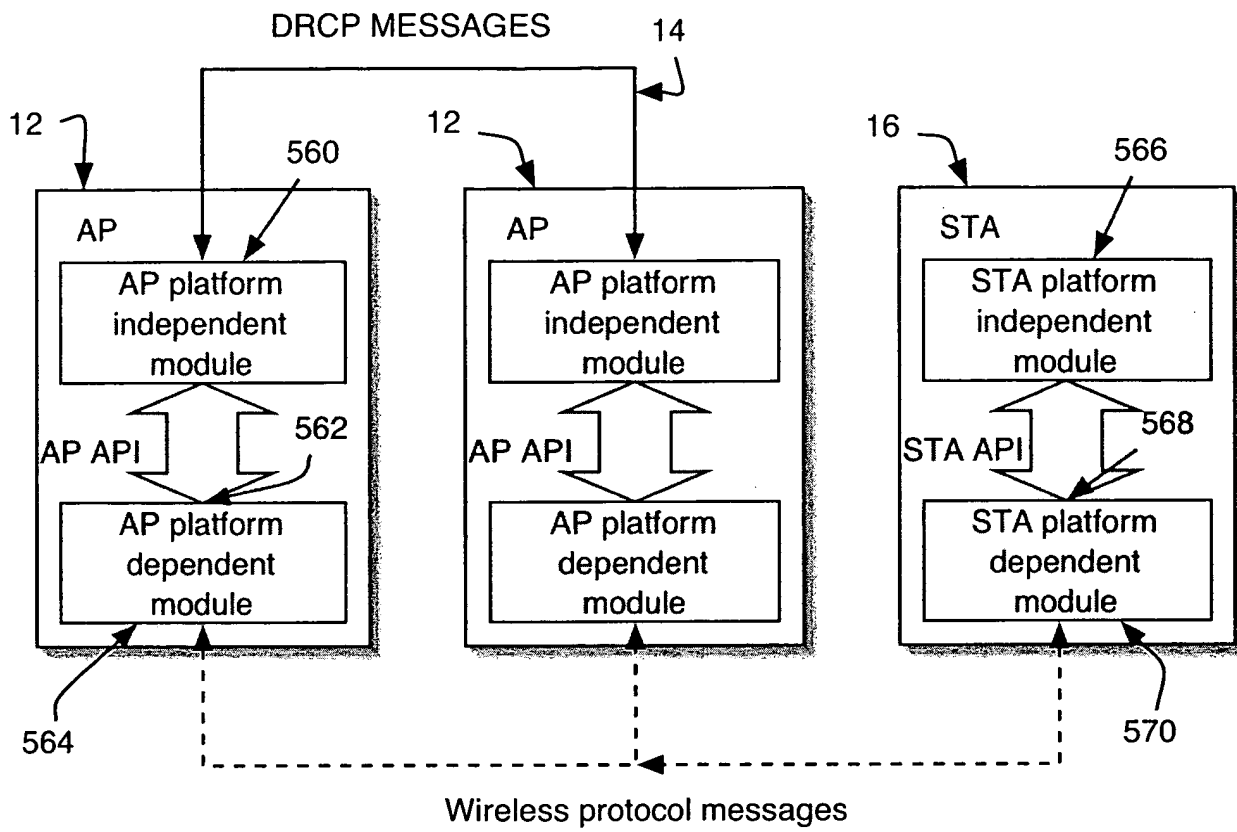

Fig. 35

802.11 AP DRCP Architecture

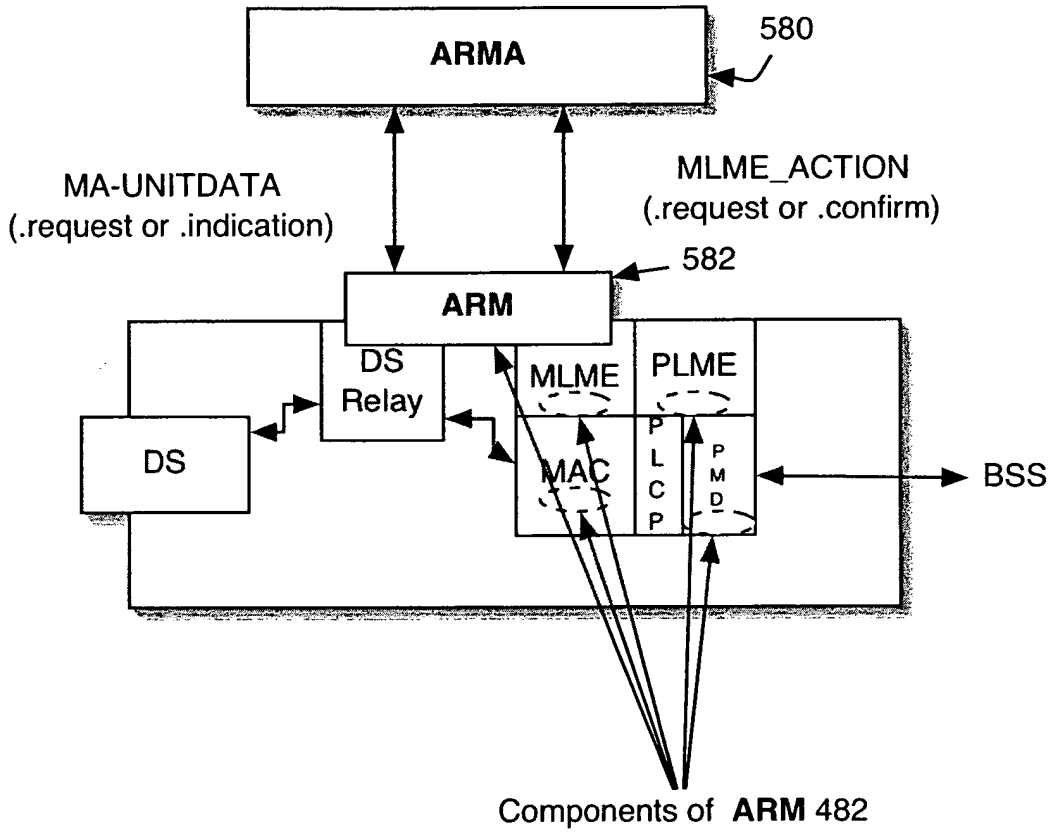

Fig. 36

802.11 STA DRCP Architecture

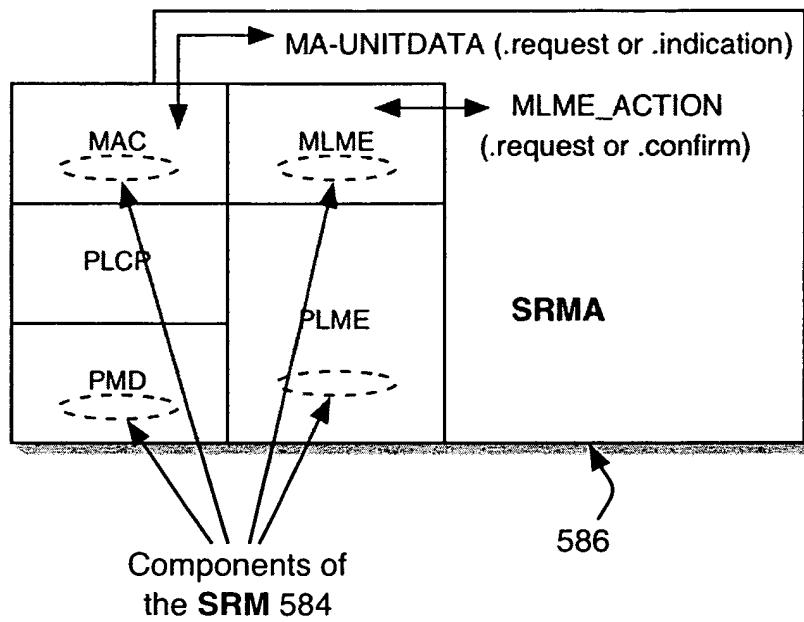

Fig. 37

Encoding of DRCP Message in an 802.11 Management Frame of Subtype Beacon

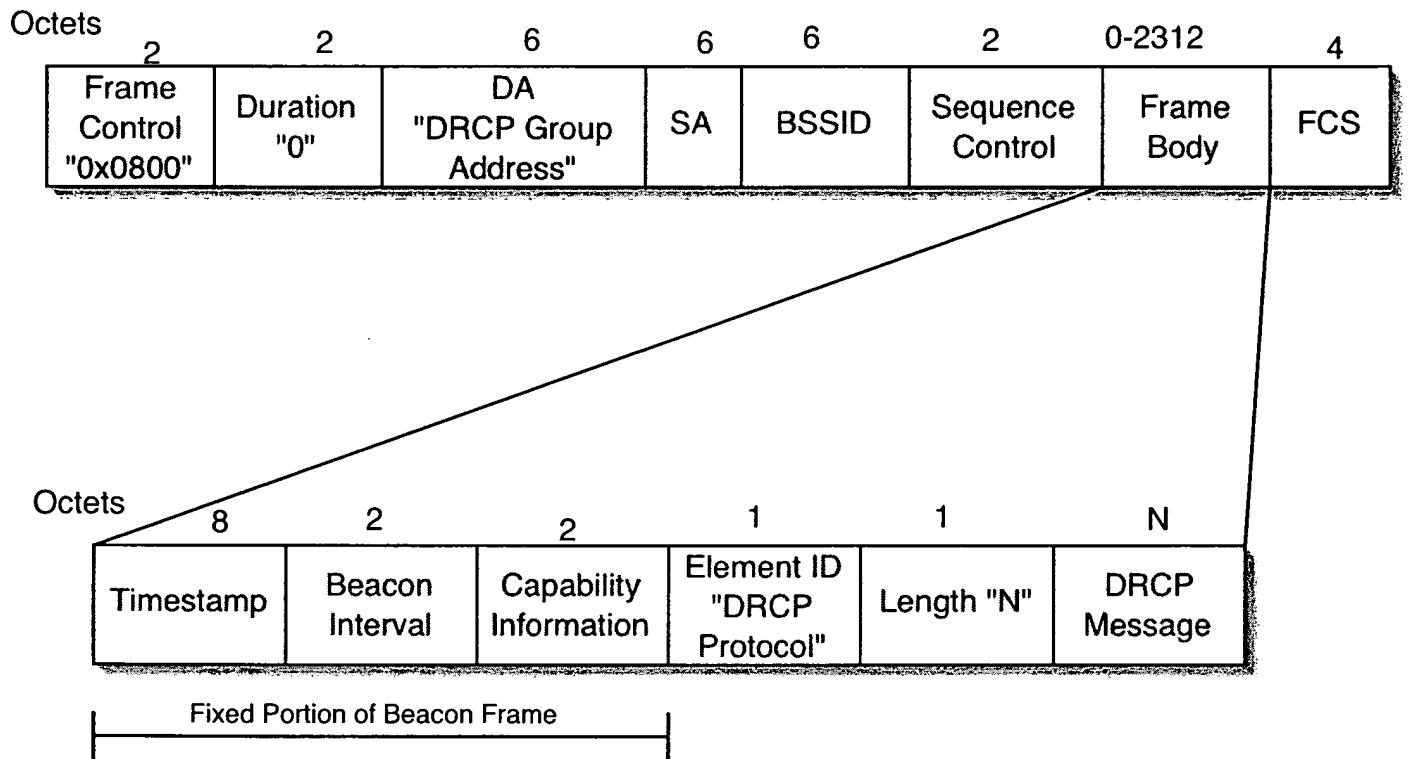

Fig. 38

Encoding of DRCP Message in an 802.11 Data Frame

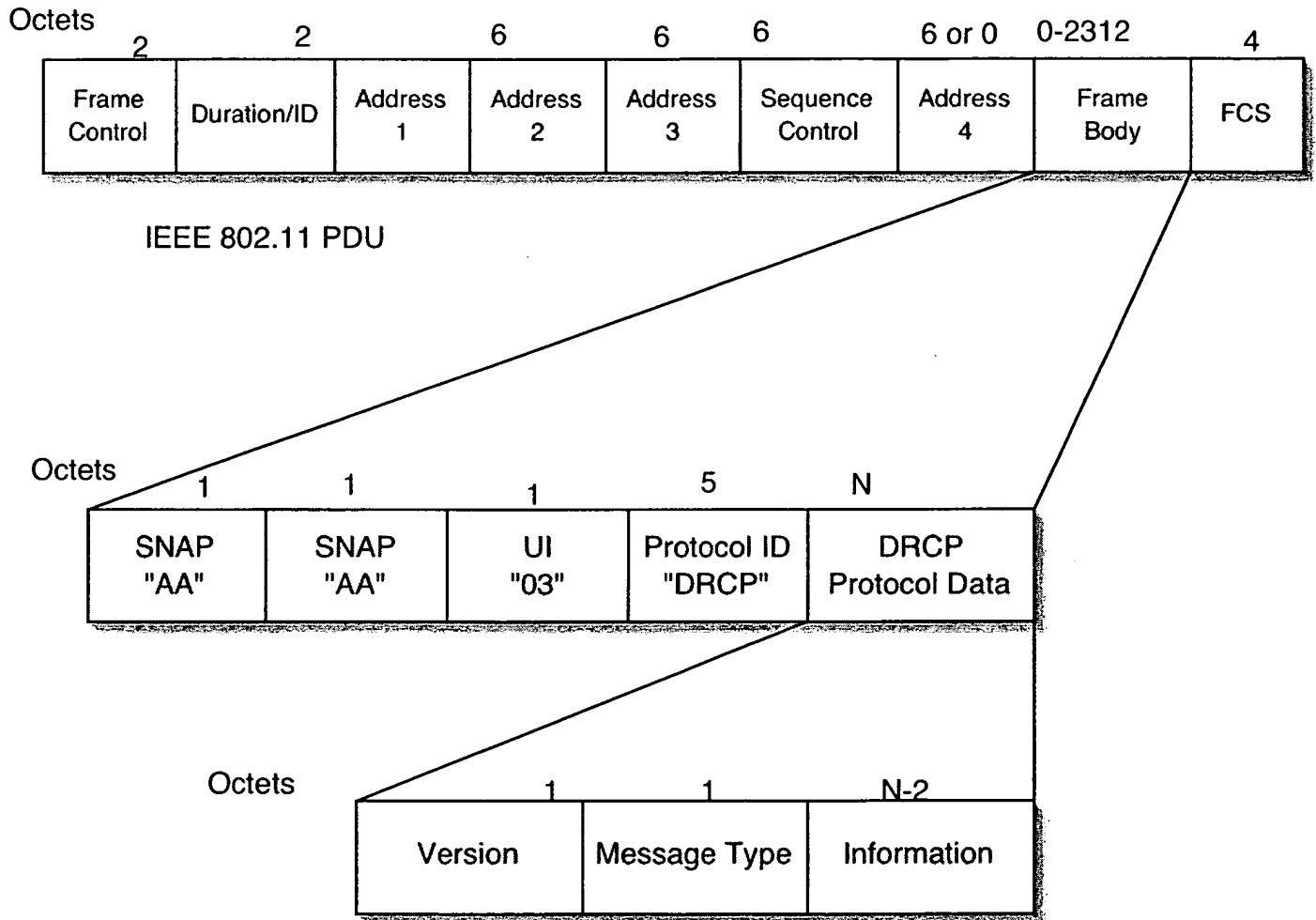

Fig. 39

Message Type	Usage	Data Rate	Max Power
DRCP Preclaim	Used by ARMAs in the channel selection process	Lowest Datarate	Max Power
DRCP Claim	Used by ARMAs in the channel selection process	Lowest Datarate	Max Power
DRCP Announce	Used by ARMAs to announce their presence to SRMAs and other ARMAs.	Lowest Datarate	Max Power
DRCP Bid	Used by SRMAs to bid for slots on ARMAs	STA Datarate	Max Power - TP Backoff
DRCP Accept	Used by ARMAs to signal to SRMAs permission to associate	STA Datarate	Max Power - TP Backoff
DRCP Registration Request	Used by STAs to tell ARMAs they will associate	STA Datarate	Max Power - TP Backoff
DRCP Registration Acknowledge	Used by ARMAs to tell STA it received registration request	STA Datarate	Max Power - TP Backoff

Fig. 40

Name	Size	Description
Type	1	Message type. Values: 1 = DRCP Claim 2 = DRCP Announce 3 = DRCP Preclaim 4 = DRCP Bid 5 = DRCP Accept 6 = DRCP Registration Request 7 = DRCP Registration Acknowledge
Channel ID	1	Indicates the channel of the originating station
AP-ID	6	The MAC Address of the AP in which the transmitting ARMA is instantiated
SSID	32	The Service Set ID (SSID) of the AP in which the transmitting ARMA is instantiated. This value is also referred to as the "Network Name".
Load Factor	2	The sum of the loads of the ATAs currently associated to the transmitting AP.
TP Backoff	2	Transmit power backoff value in use by the transmitting AP.
Max Power	2	Maximum pwer output, in dBm, of the transmitting AP's radio.
Biased Distance Delta	4	The difference between the biased distance from the transmitting STA to its current AP and the destination AP.
STA ID	6	The MAC address of the STA in which the transmitting SRMA is instantiated.
STA Assoc AP ID	6	The MAC address of the AP to which the transmitting STA is currently associated.
Bid AP ID	6	The MAC address of the AP to which the transmitting STA is bidding.
Accepted STA ID	6	The MAC address of the STA that the sending AP is accepting.
STA Reported AP ID	6	The MAC address of the AP that was identified in the last Bid message as the accepted STA's associated AP.
Max TP Backoff	2	Max dB's backoff capable of an AP
Adjacency Vector Sum	2	Sum of received power levels from all APs heard during scanning and preclaiming.

Fig. 41

Byte Address

0	Version	Type	Flags	Channel ID
4	AP ID (MSBs)			
8	AP ID (LSBs)		Max Backoff Max power	

DRCP Preclaim Message

Fig. 42

Byte Address

0	Version	Type	Flags	Channel ID
4	AP ID (MSBs)			
8	AP ID (LSBs)		Max Backoff Max Power	
12	Adjacency Vector Sum		Reserved	

DRCP Claim Message

Fig. 43

Byte Address

0	Version	Type	Flags	Channel ID
4	AP ID (MSBs)			
8	AP ID (LSBs)		Max Backoff Max Power	
12	TP Backoff Reserved		Load Factor	

DRCP Announce Message

Fig. 44

Byte Address

0	Version	Type	Flags	Channel ID
4	Biased Distance Delta			
8	STA ID (MSBs)			
12	STA ID (LSBs)		STA Assoc AP ID (MSBs)	
16	STA Assoc AP ID (LSBs)			
20	Bid AP ID (MSBs)			
24	Bid AP (LSBs)		Reserved	

DRCP Bid Message

Fig. 45

Byte Address

0	Version	Type	Flags	Channel ID
4	AP ID (MSBs)			
8	AP ID (LSBs)		Accepted STA ID (MSBs)	
12	Accepted STA ID (LSBs)			
16	STA Reported AP ID (MSBs)			
20	STA Reported AP ID (LSBs)		Reserved	

DRCP Accept Message

Fig. 46

Byte Address

0	Version	Type	Flags	Channel ID
4	AP ID (MSBs)			
8	AP ID (LSBs)		Accepted STA ID (MSBs)	
12	Accepted STA ID (LSBs)			

DRCP Registration Request Message

Fig. 47

Byte Address

0	Version	Type	Flags	Channel ID
4	AP ID (MSBs)			
8	AP ID (LSBs)		Accepted STA ID (MSBs)	
12	Accepted STA ID (LSBs)			

DRCP Registration Acknowledge Message

Fig. 48

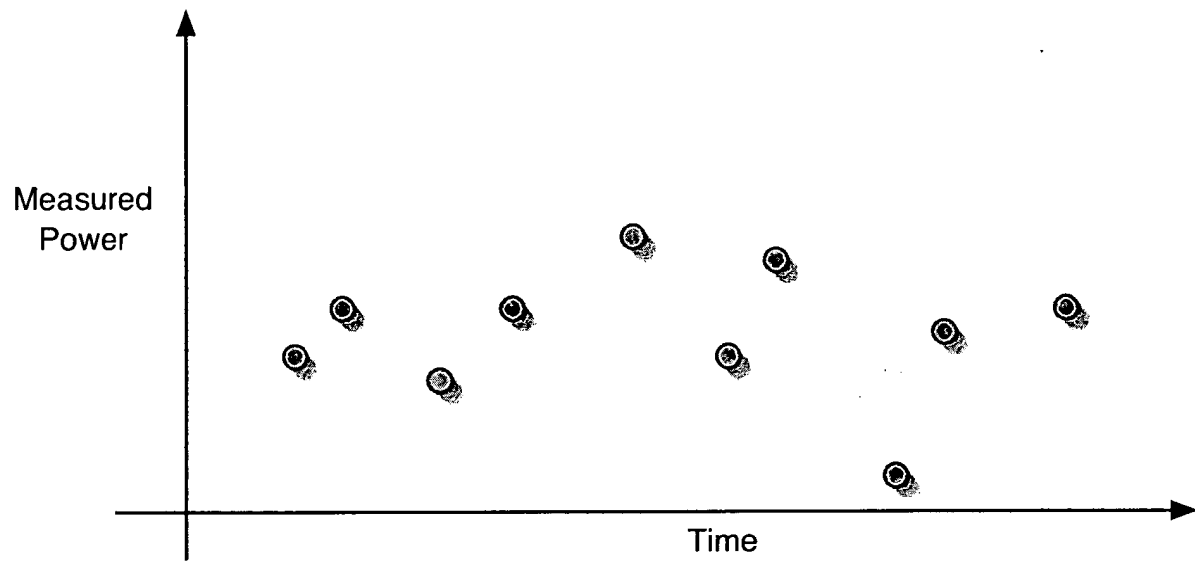

Fig. 49

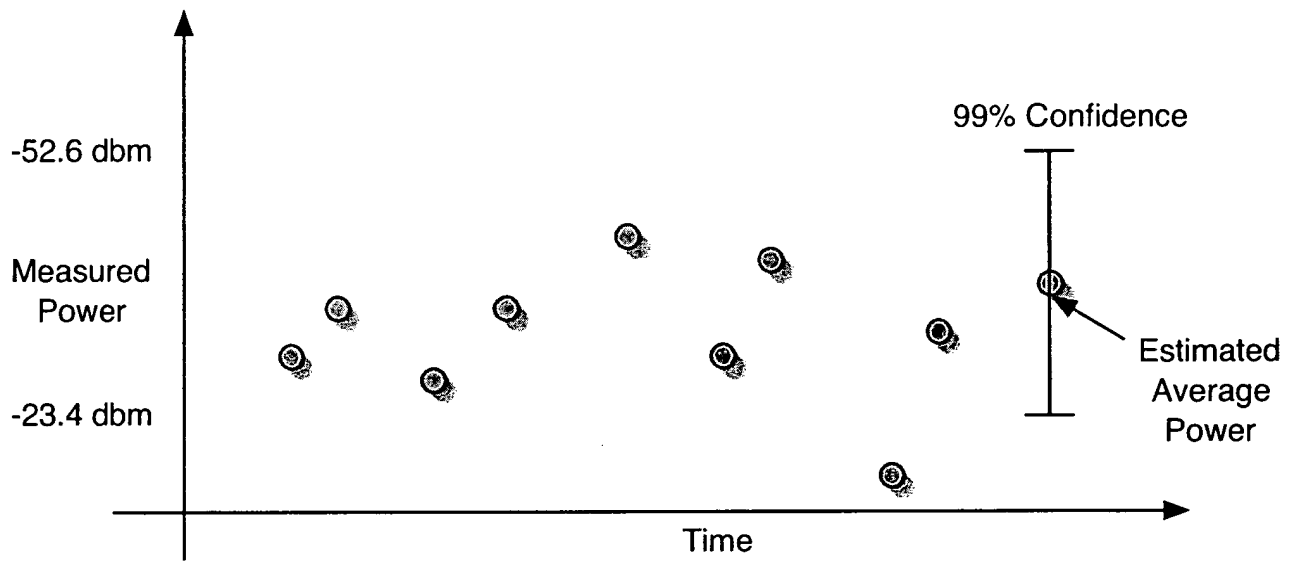

Fig. 50

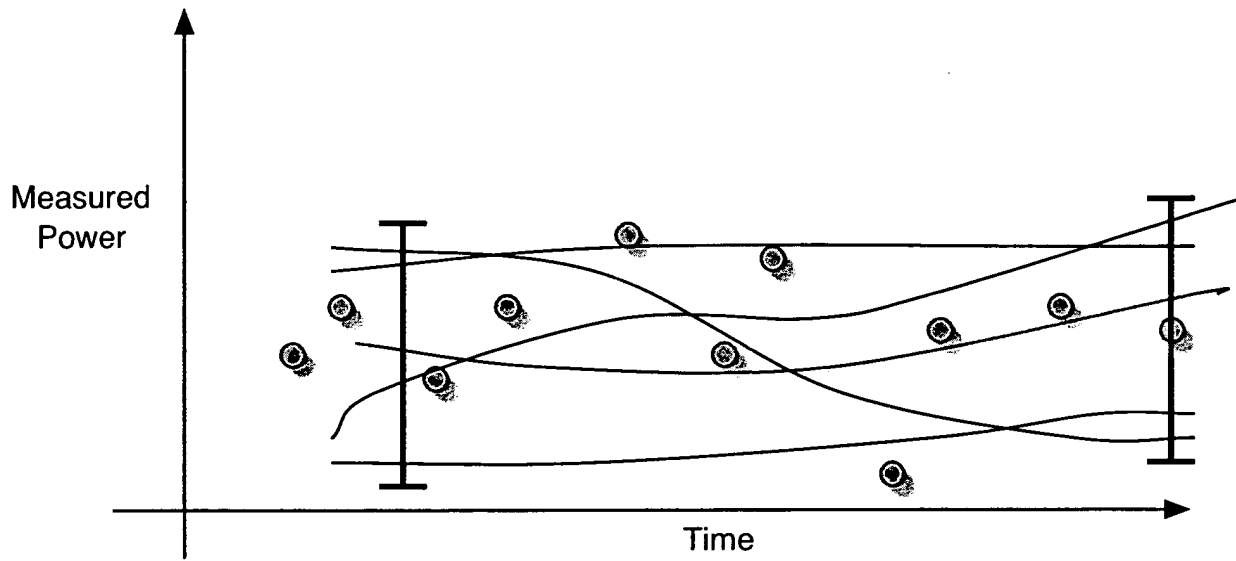

Fig. 51

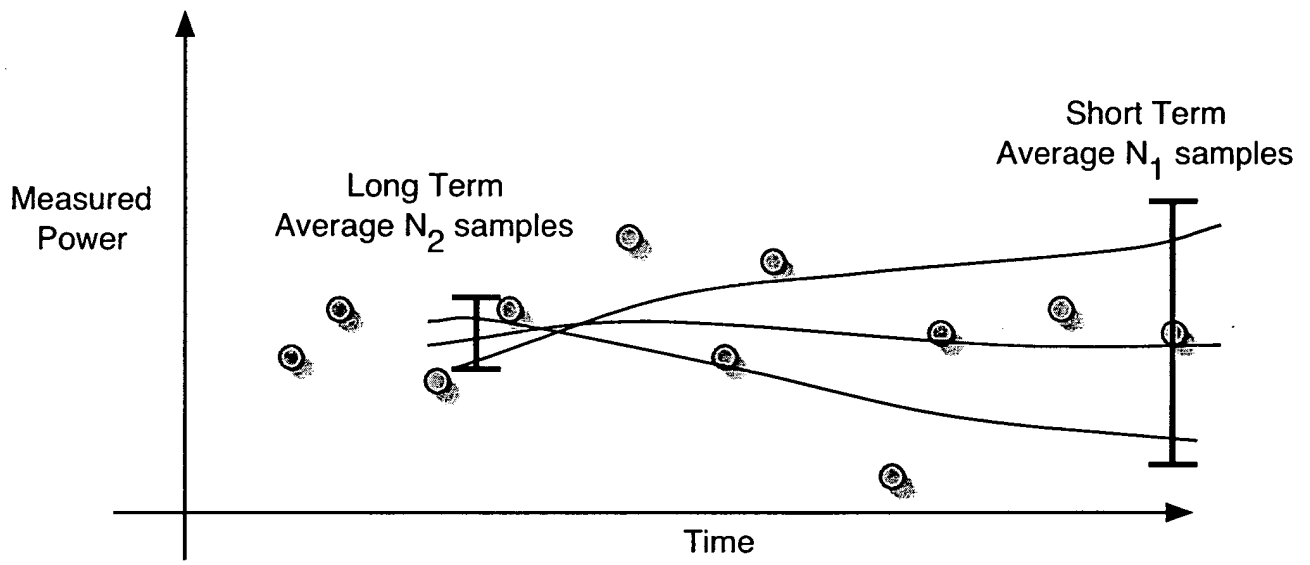

Fig. 52

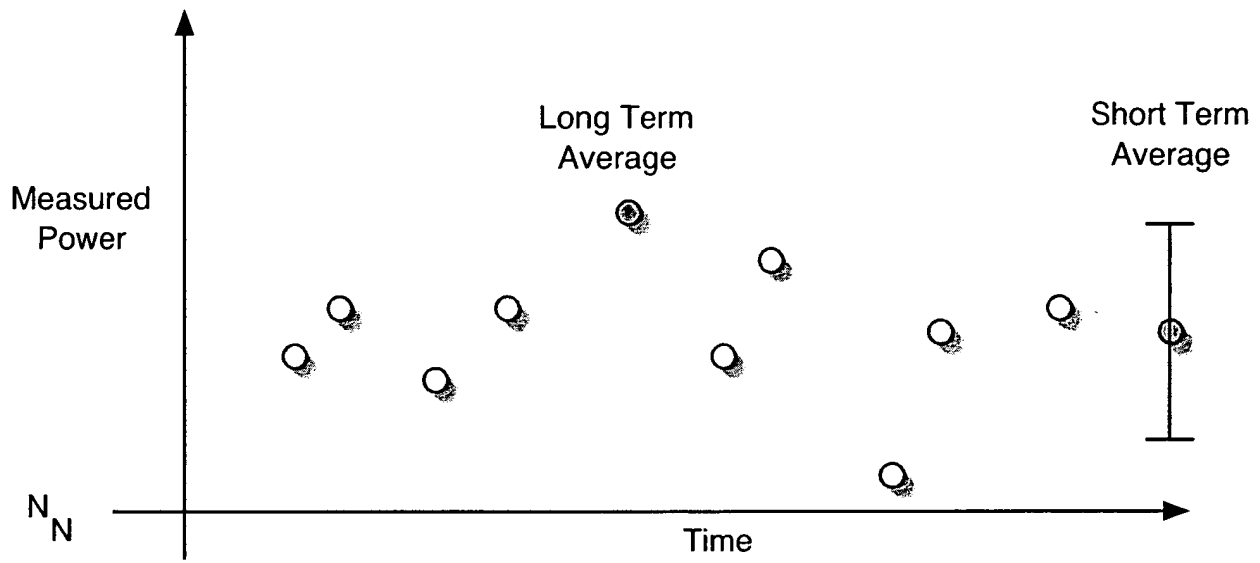

Fig. 53

Sample Time Duration	# Power Samples (N2)	Upper 99% Confidence Interval	Lower 99% Confidence Interval
1 sec	20	-29.1 dbm	-46.9 dbm
10 sec	200	-35.3 dbm	-40.7 dbm
100 sec	2000	-37.2 dbm	-38.3 dbm
1000 sec	20,000	-37.7 dbm	-38.3 dbm

Fig. 54

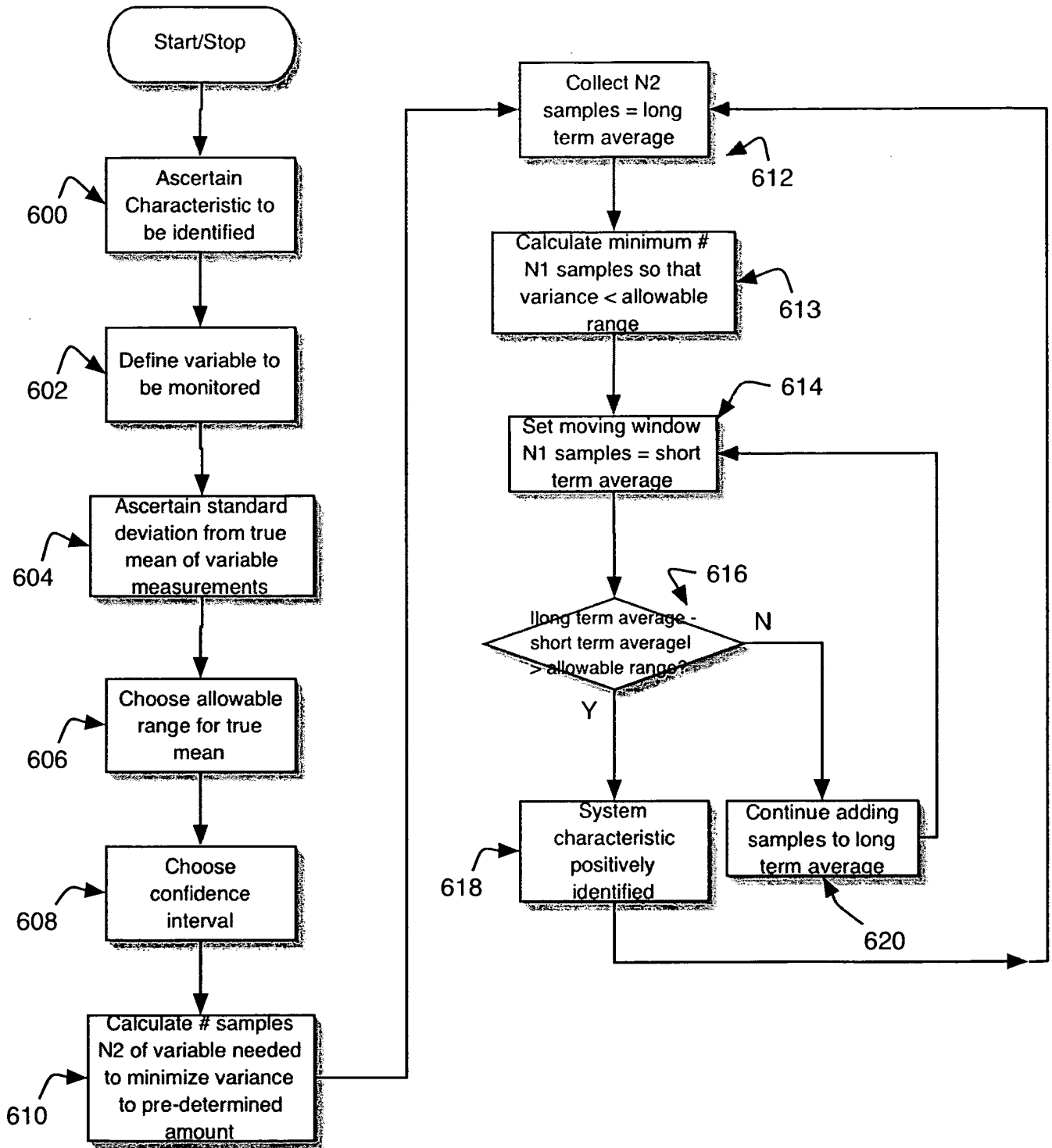

Fig. 55

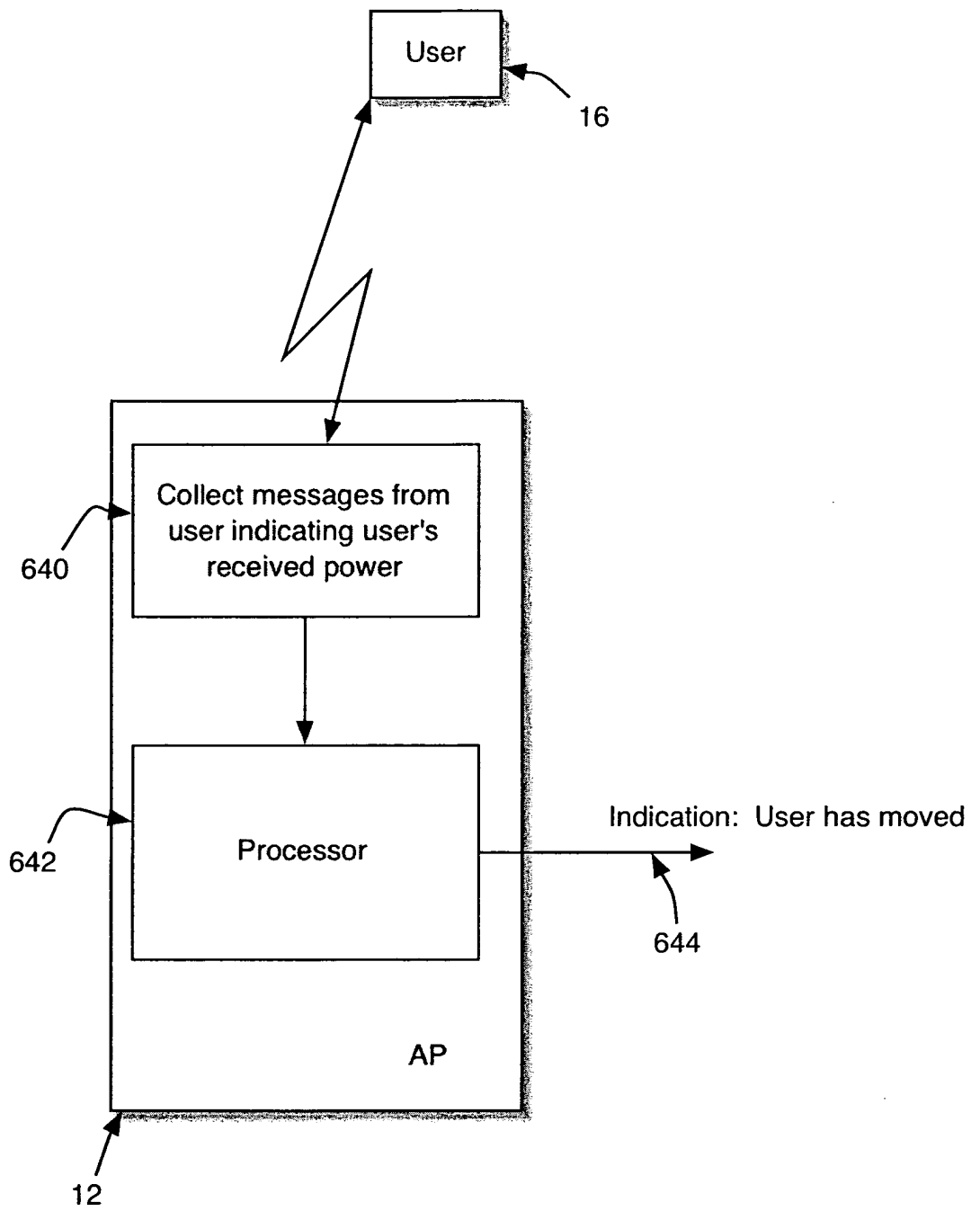

Fig. 56

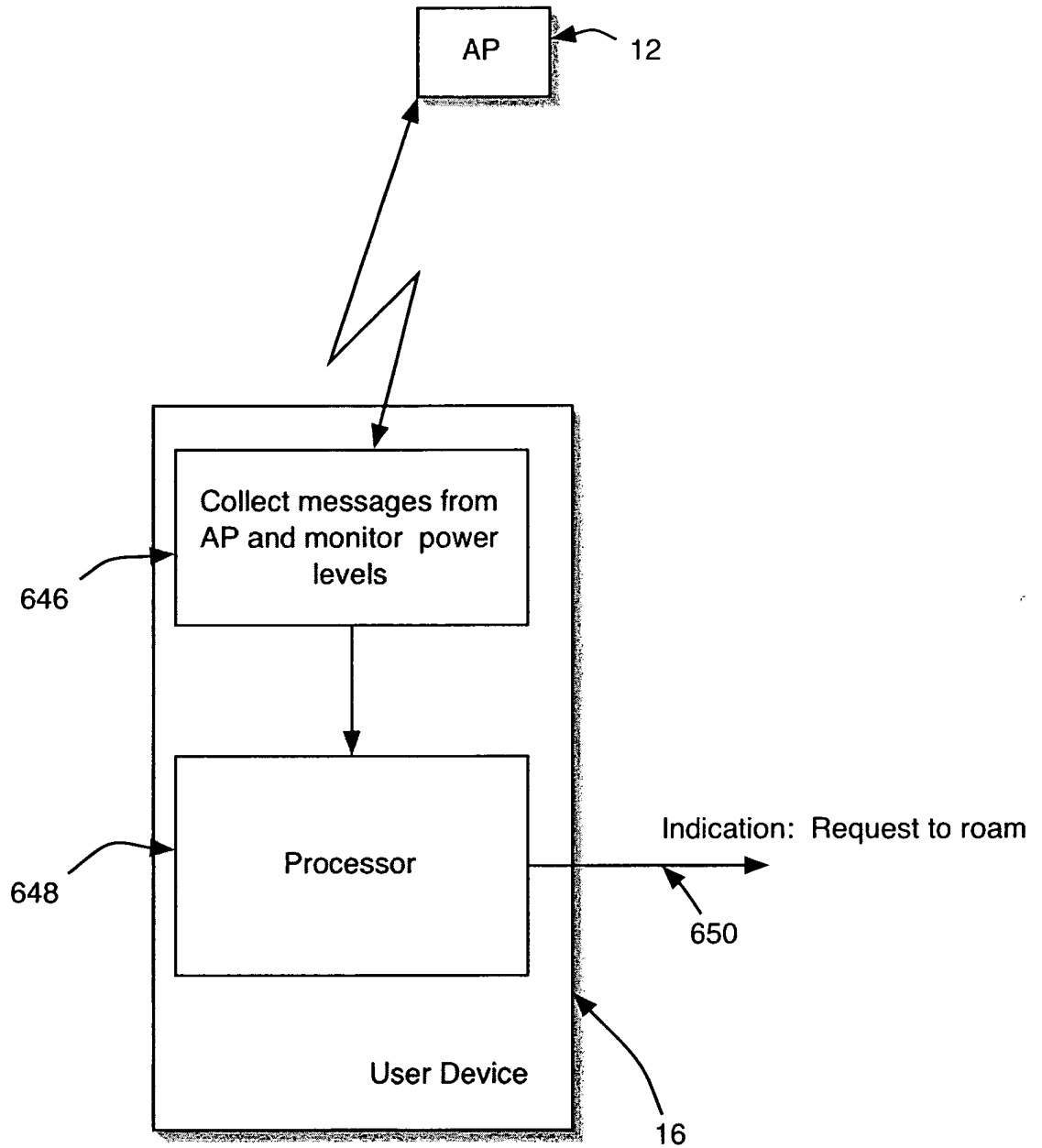

Fig. 57

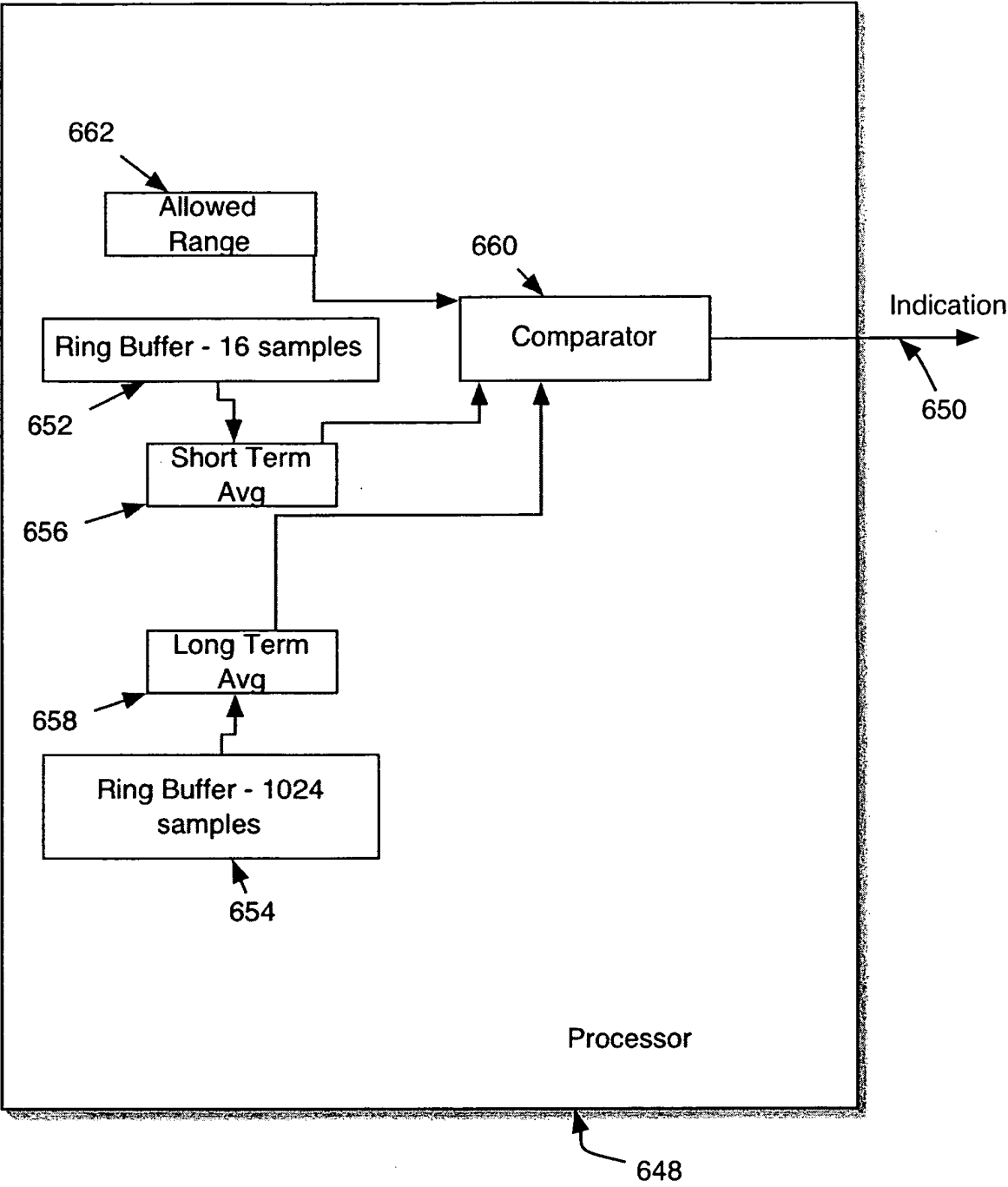

Fig. 58

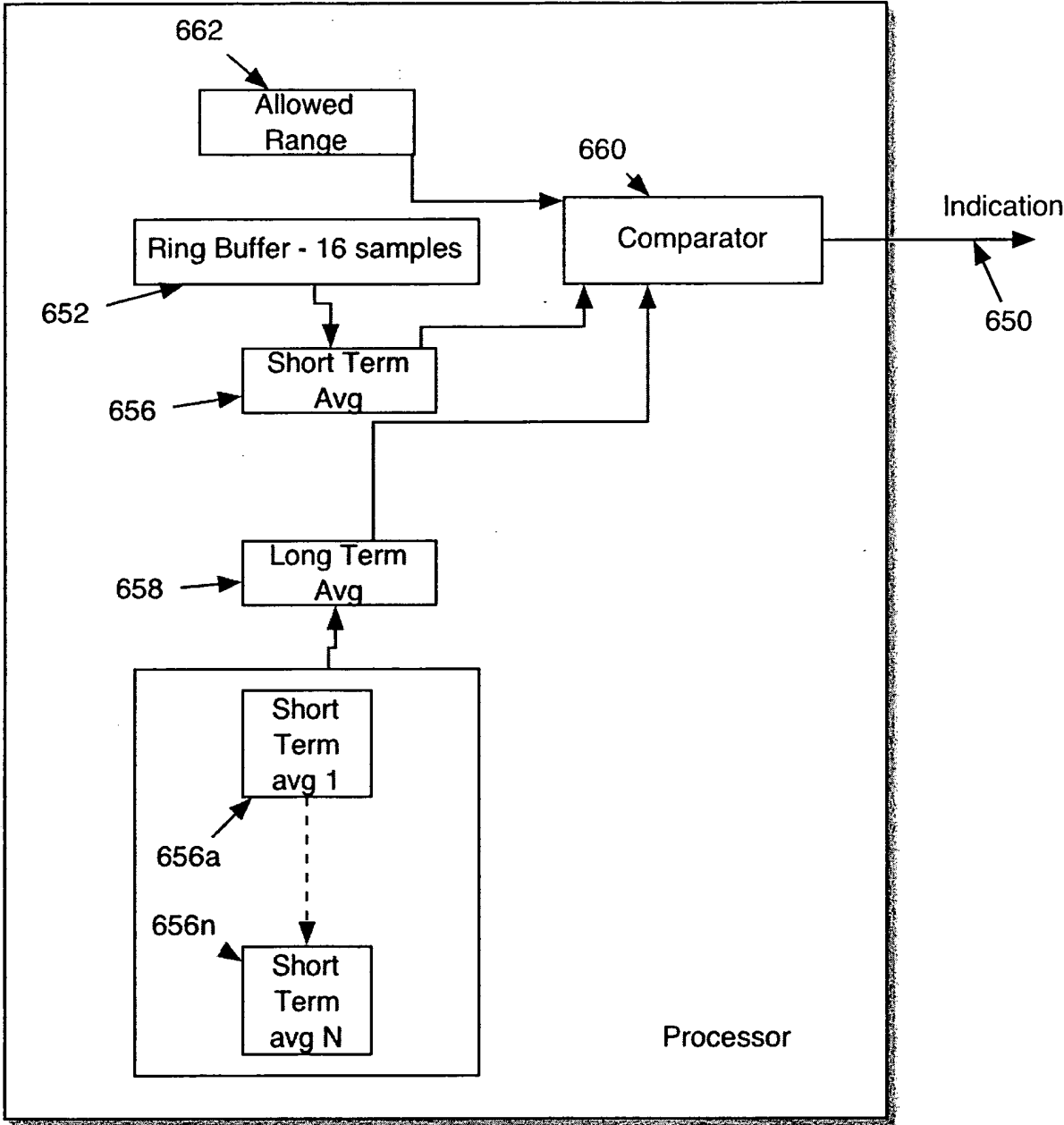

Fig. 59